

Material of the ventilator Flame Retardant ABS Resin
 Material of filter screen resin mixed with nylon fiber
 Scope: room temperature from -10 to +55
 Dust removal rate: 89%
 IP code: IP40

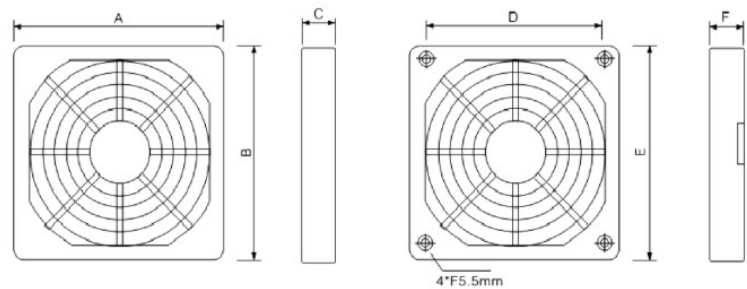

Model Size(mm)	A	B	C	D	E	F	Weight g
FK2040	44	44	7	32	40	3	6

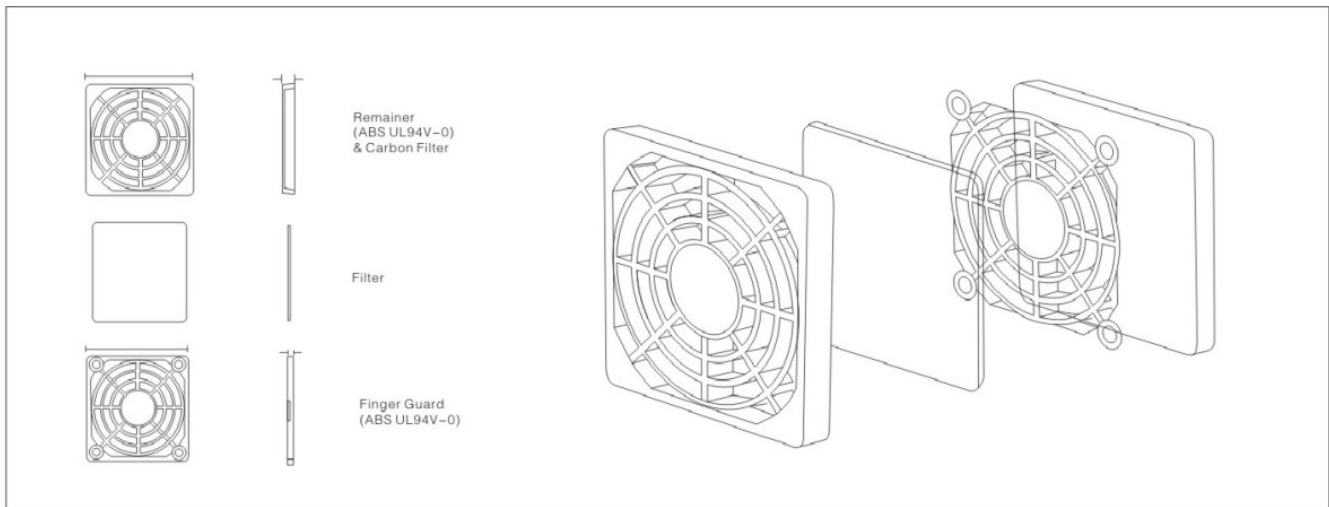
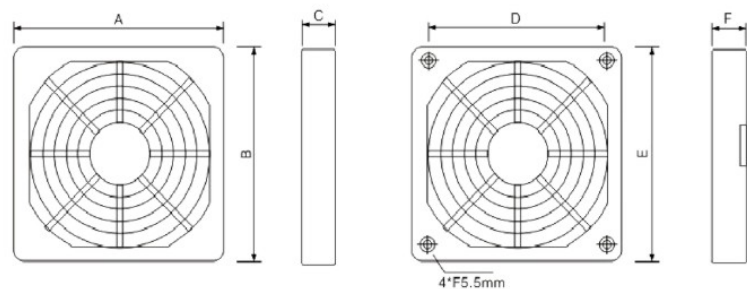

Model Size(mm)	A	B	C	D	E	F	Weight g
FK2050	54	54	7	40	50	3	10

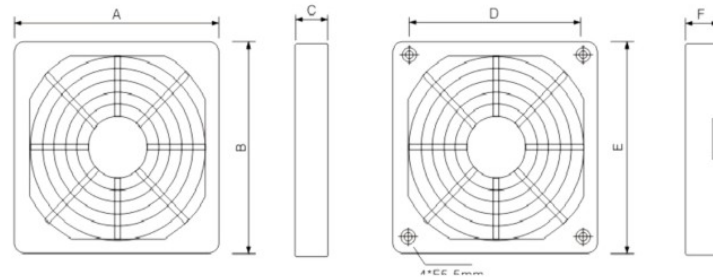

Model Size (mm)	A	B	C	D	E	F	Weight g
FK2060	64	64	7	50	61	3	11

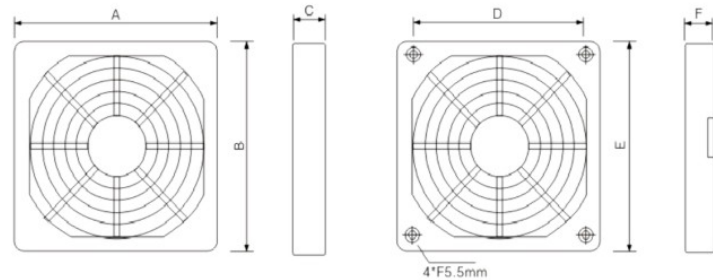

Model Size (mm)	A	B	C	D	E	F	Weight g
FK2070	75	75	7	61.5	70	3	14

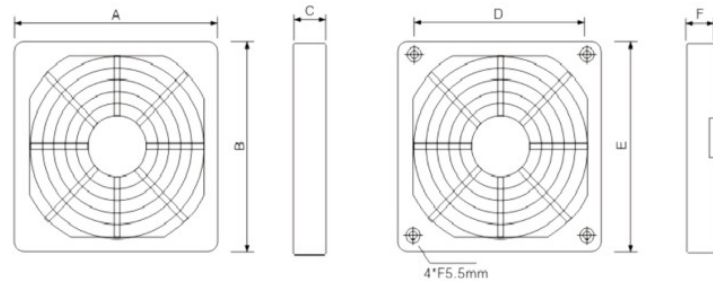

Model Size (mm)	A	B	C	D	E	F	Weight g
FK2080	86	86	11	71.5	83	4.5	36

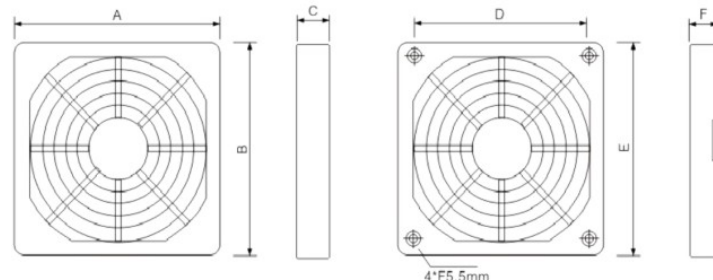

Model Size (mm)	A	B	C	D	E	F	Weight g
FK2090	97	97	11	82.5	92	5	44

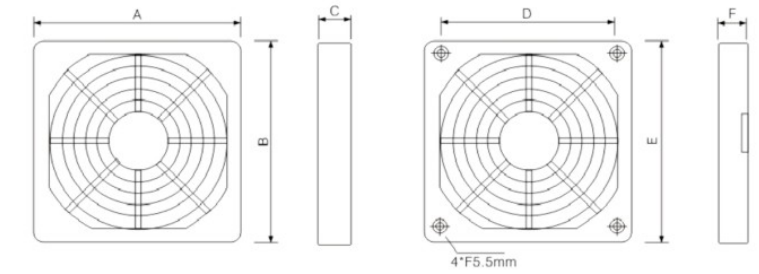

Model Size (mm)	A	B	C	D	E	F	Weight g
FK2110	115	115	11	88.3	110	5	73

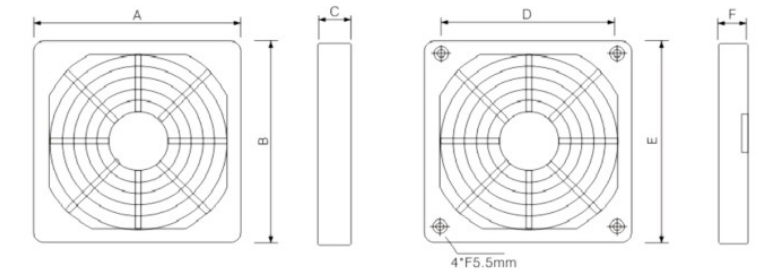

Model Size (mm)	A	B	C	D	E	F	Weight g
FK2120	125	125	10	105	120	5	74

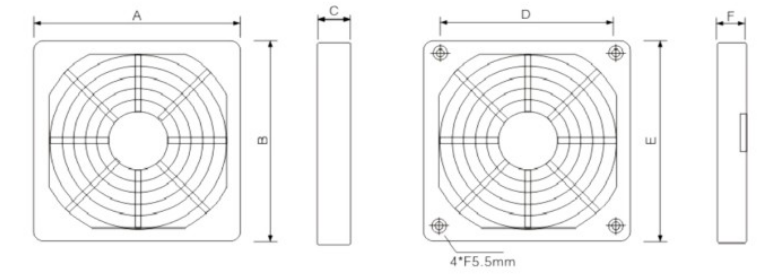

Model Size (mm)	A	B	C	D	E	F	Weight g
FK2135	140	140	10	110	135	5	78

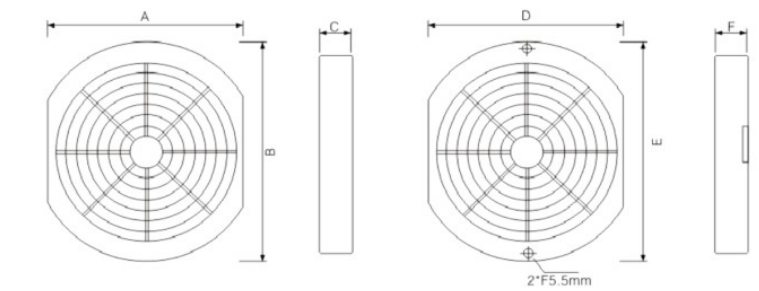

Model Size (mm)	A	B	C	D	E	F	Weight g
FK2150	155	177	10	150	162	5	115

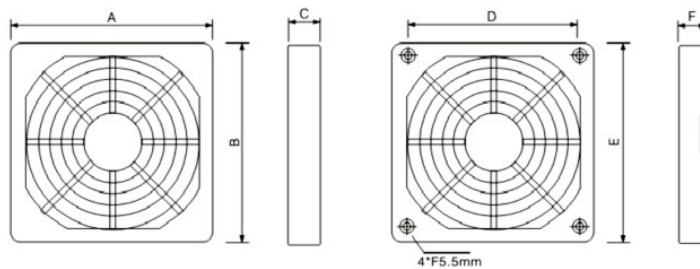

Model	A	B	C	D	E	F	Weight g
FK2172	178	178	10	123	172	5	163

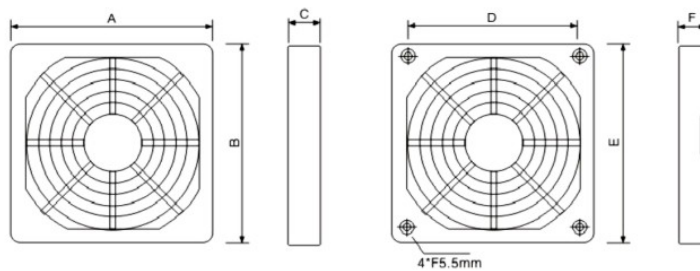

Model	A	B	C	D	E	F	Weight g
FK2200	206	206	10	166	200	4.5	210