







Picture

TECHNICAL PROPERTIES

 <p>DOSSY® CE</p>	<p>Model: DS5210-U P/N: MV901 Display: 000.0 Ratio: Available 0-9999V Size: 96*96mm</p>	<p>Power Supply: AC153-265V 50/60Hz Measure range: 10-600V Net weight: 250g</p>
 <p>DOSSY® CE</p>	<p>Model: DS5210-I P/N: MI901 Display: 0.000 Ratio: Available 0-9999A Size: 96*96mm</p>	<p>POWER SUPPLY: AC153-265V 50/60Hz Measure range: 0.025-6A Net weight: 258g</p>
 <p>DOSSY® CE</p>	<p>Model: DS5210-F P/N: MF901 Display: 00.00 Ratio: NONE Size: 96*96mm</p>	<p>POWER SUPPLY: AC153-265V 50/60Hz Measure range: 45-65HZ Net weight: 250g</p>
 <p>DOSSY® CE</p>	<p>Model: DS5210-P P/N: MP901 Display: 000.0 Ratio: 0-9999KW Size: 96*96mm</p>	<p>POWER SUPPLY: AC153-265V 50/60Hz Measure range: 0-9999KW Net weight: 262g</p>
 <p>DOSSY® CE</p>	<p>Model: DS5210-3U P/N: MV902 Display: 000.0 Ratio: Available 0-9999KV Size: 96*96mm</p>	<p>POWER SUPPLY: AC153-265V 50/60Hz Measure range: Three phase 4.5-264V Net weight: 286g</p>
 <p>DOSSY® CE</p>	<p>Model: DS5210-3I P/N: MI902 Display: 0.000 Ratio: Available 0-9999KA Size: 96*96mm</p>	<p>POWER SUPPLY: AC153-265V 50/60Hz Measure range: Three phase 0.025-6A Net weight: 305g</p>
 <p>DOSSY® CE</p>	<p>Model: DS5210-UIF P/N: M931 Display: 000.0 Ratio: Available 0-9999KA 0-9999KV Size: 96*96mm</p>	<p>POWER SUPPLY: AC153-265V 50/60Hz Measure range: 8-456V 0-5A 45-65HZ Net weight: 289g</p>
 <p>DOSSY® CE</p>	<p>Model: DS5210-UIP P/N: M932 Display: 000.0 Ratio: Available 0-9999A 0-9999kv Size: 96*96mm</p>	<p>POWER SUPPLY: AC153-265V 50/60Hz Measure range: 8-456V 0.025-6A 0-9999KW Net weight: 289g</p>

Picture

TECHNICAL PROPERTIES

DOSSY



Model:

DS5210-M

P/N:

MM901

Display:

000.0

Ratio:

**Available
0-9999A
0-9999kv**

Size:

96*96

POWER SUPPLY:

AC153-265V 50/60Hz

Measure range:

**5V-264V
0.05-6A
45-65Hz**

Net weight:

321g

DOSSY®



Model:

DS6210-D

P/N:

MD901

Display:

000.0

Ratio:

**Available
0-9999A
0-9999kv**

Size:

96*96

POWER SUPPLY:

140-265V 50/60HZ

Measure range:

**0-220V
0-5A
45-65Hz**

Net weight:

415g

Drawing :

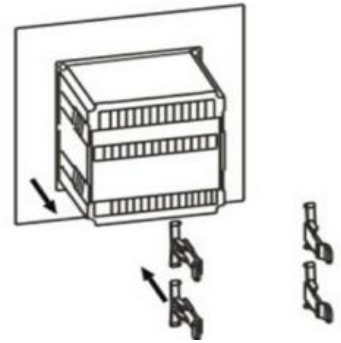
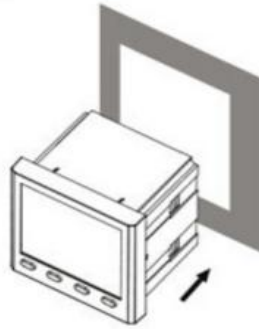
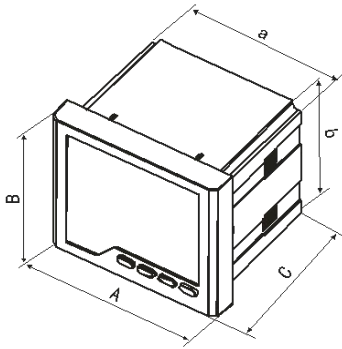









(A×B)	(a×b)	C
96×96mm	90×90mm	92mm

Packing information:48PCS/CTN 41*33*41CM

Picture

TECHNICAL PROPERTIES

 <p>DOSSY® CE</p>	Model:	DS5220-I	POWER SUPPLY:	AC153-265V 50/60Hz
	P/N:	MI903	Measure range:	0.025-6A
 <p>DOSSY® CE</p>	Display:	0.000	Net weight:	212g
	Ratio:	Available 0-9999A	POWER SUPPLY:	AC153-265V 50/60Hz
 <p>DOSSY® CE</p>	Size:	96*48mm	Measure range:	10-600V
	Model:	DS5220-U	Net weight:	205g
 <p>DOSSY® CE</p>	P/N:	MV903	POWER SUPPLY:	AC153-265V 50/60Hz
	Display:	000.0	Measure range:	45-65HZ
 <p>DOSSY® CE</p>	Ratio:	Available 0-9999V	Net weight:	205g
	Size:	96*48mm	POWER SUPPLY:	AC153-265V 50/60Hz
 <p>DOSSY® CE</p>	Model:	DS5220-F	Measure range:	0.25-9999KW
	P/N:	MF902	Net weight:	217g
 <p>DOSSY® CE</p>	Display:	00.00	POWER SUPPLY:	AC153-265V 50/60Hz
	Ratio:	NONE	Measure range:	0.25-9999KW
 <p>DOSSY® CE</p>	Size:	96*48mm	Net weight:	217g
	Model:	DS5220-P	POWER SUPPLY:	AC153-265V 50/60Hz
 <p>DOSSY® CE</p>	Code:	MP902	Measure range:	0.25-9999KW
	Display:	000.0	Net weight:	217g
 <p>DOSSY® CE</p>	Ratio:	Available 0-9999kw	POWER SUPPLY:	AC153-265V 50/60Hz
	Size:	96*48mm	Measure range:	0.25-9999KW
 <p>DOSSY® CE</p>	Model:	DS5220-P	Net weight:	217g
	Code:	MP902	POWER SUPPLY:	AC153-265V 50/60Hz
 <p>DOSSY® CE</p>	Display:	000.0	Measure range:	0.25-9999KW
	Ratio:	Available 0-9999kw	Net weight:	217g
 <p>DOSSY® CE</p>	Size:	96*48mm	POWER SUPPLY:	AC153-265V 50/60Hz
	Model:	DS5220-P	Measure range:	0.25-9999KW
 <p>DOSSY® CE</p>	Code:	MP902	Net weight:	217g
	Display:	000.0	POWER SUPPLY:	AC153-265V 50/60Hz
 <p>DOSSY® CE</p>	Ratio:	Available 0-9999kw	Measure range:	0.25-9999KW
	Size:	96*48mm	Net weight:	217g

Drawing :

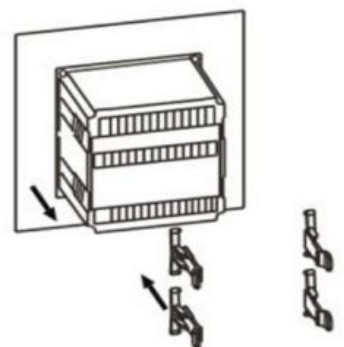
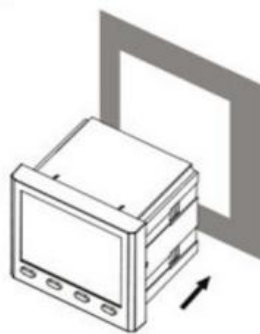
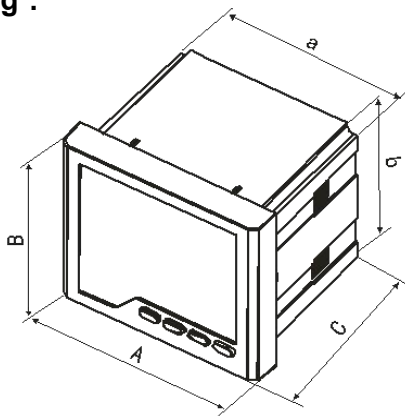

(A×B)	(a×b)	C
96×48mm	90×44mm	92mm

Packing information: 40PCS/CTN 41*33*41CM

Picture

TECHNICAL PROPERTIES

	Model: Code: Display: Ratio: Size:	DS5230S-U MV904 000.0 Available 0-9999V 72*72	POWER SUPPLY: Measure range: Net weight:	AC153-265V 50/60Hz 10-600V 187g
	Model: Code: Display: Ratio: Size:	DS5230S-I MI904 0.000 Available 0-9999A 72*72	POWER SUPPLY: Measure range: Net weight:	AC153-265V 50/60Hz 0.01-6A 192g
	Model: Code: Display: Ratio: Size:	DS5230S-F MF903 00.00 NONE 72*72	POWER SUPPLY: Measure range: Net weight:	AC153-265V 50/60Hz 45-65HZ 187g
	Model: Code: Display: Ratio: Size:	DS5230-P MP903 000.0 Available 0-9999A 72*72	POWER SUPPLY: Measure range: Net weight:	AC153-265V 50/60Hz 0.025-6A 10-380V 213g
	Model: Code: Display: Ratio: Size:	DS5230-UIF M933 000.0 Available 0-9999A 72*72	POWER SUPPLY: Measure range: Net weight:	AC153-265V 50/60Hz 8-456V 0.025-6a 45-65HZ 229g
	Model: Code: Display: Ratio: Size:	DS5230-UIP M934 000.0 Available 0-9999A 72*72	POWER SUPPLY: Measure range: Net weight:	AC153-265V 50/60Hz 8-456V 0.025-6A 45-65HZ 229g
	Model: Code: Display: Ratio: Size:	DS5230-3I MI908 0.000 Available 0-9999A 72*72	POWER SUPPLY: Measure range: Net weight:	AC153-265V 50/60Hz 0.025-6A 247g
	Model: Code: Display: Ratio: Size:	DS5230-3U MV908 000.0 Available 0-9999kv 72*72	POWER SUPPLY: Measure range: Net weight:	AC153-265V 50/60Hz 4.5-264V 226g

Drawing :

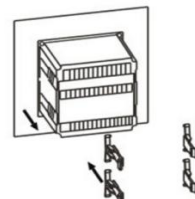
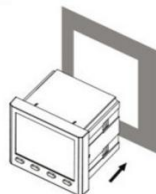
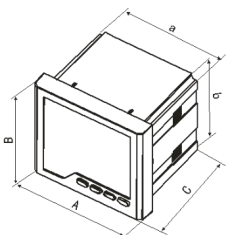

(AXB)	(axb)	C
72*72	67*67	92mm

Packing information: short tpe 30PCS/CTN 45*27*21CM
 long tpe 100PCS/CTN 43*35*42CM

Picture

TECHNICAL PROPERTIES

	Model: Code: Display: Ratio: Size:	DS5250S-U MV906 000.0 Available 0-9999V 80*80	POWER SUPPLY: Measure range: Net weight:	AC153-265V 50/60Hz 10-600V 207g
	Model: Code: Display: Ratio: Size:	DS5250S-I MI906 0.000 Available 0-9999A 80*80	POWER SUPPLY: Measure range: Net weight:	AC153-265V 50/60Hz 0.01-6A 216g
	Model: Code: Display: Ratio: Size:	DS5250S-F MF904 00.00 NONE 80*80	POWER SUPPLY: Measure range: Net weight:	AC153-265V 50/60Hz 45-65HZ 207g
	Model: Code: Display: Ratio: Size:	DS5250-3I MI905 0.000 Available 80*80	POWER SUPPLY: Measure range: Net weight:	AC153-265V 50/60Hz 0.025-6A 254g
	Model: Code: Display: Ratio: Size:	DS5250-3U MV905 000.0 Available 0-9999kV 80*80	POWER SUPPLY: Measure range: Net weight:	AC153-265V 50/60Hz 4.5-264V 233g
	Model: Code: Display: Ratio: Size:	DS5250-UIF M935 000.0 Available 0-9999A 80*80	POWER SUPPLY: Measure range: Net weight:	AC153-265V 50/60Hz 8-456V 0.025-6A 45-65HZ 236g
	Model: Code: Display: Ratio: Size:	DS5250-UIP M936 000.0 Available 0-9999A 80*80	POWER SUPPLY: Measure range: Net weight:	AC153-265V 50/60Hz 8-456V 0.025-6A 45-65HZ 236g

Drawing :

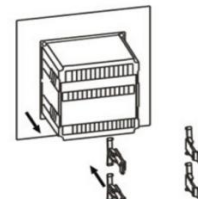
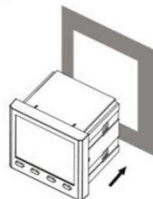
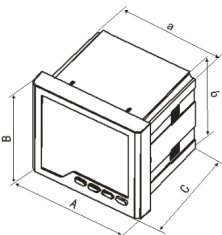



(AXB)	(axb)	C
80*80mm	67*67mm	92mm

Packing information: short tpe 30PCS/CTN 45*27*21CM
 long tpe 100PCS/CTN 43*35*42CM

Picture

TECHNICAL PROPERTIES

	Model:	DS5240-I	POWER SUPPLY: AC153-265V 50/60Hz	AC153-265V 50/60Hz
	Code:	MI907		
	Display:	0.000		
	Ratio:	Available 0-9999A		
	Size:	48*48		
	Model:	DS5240-U	POWER SUPPLY: AC153-265V 50/60Hz	AC153-265V 50/60Hz
	Code:	MV907		
	Display:	000.0		
	Ratio:	Available 0-9999V		
	Size:	48*48		
	Model:	DS5240-F	POWER SUPPLY: AC153-265V 50/60Hz	AC153-265V 50/60Hz
	Code:	MF905		
	Display:	00.00		
	Ratio:	NONE		
	Size:	48*48		
	Measure range:	0.025-6A		0.025-6A
	Net weight:	167g		167g
	Measure range:	10-600V		10-600V
	Net weight:	160g		160g
	Measure range:	45-65HZ		45-65HZ
	Net weight:	160g		160g

Drawing :

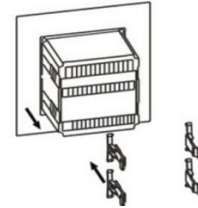
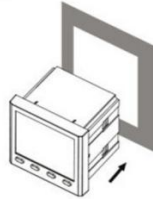
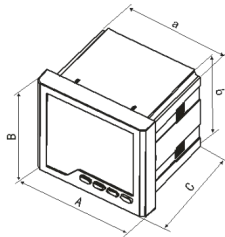

(AXB)	(axb)	C
48*48mm	44*44mm	92mm

Packing information: 70PCS/CTN 45*27*21CM