

INSTRUCTION MANUAL

NT511

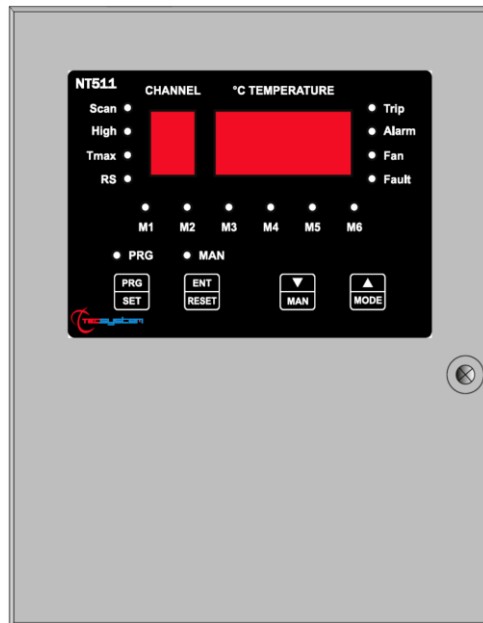

1MN0138 REV. 0



operates with ISO9001 certified quality system

TECSYSTEM S.r.l.
20094 Corsico (MI)
Tel.: +39-024581861
Fax: +39-0248600783

<http://www.tecsystem.it>

R. 1.2 26/11/20

ENGLISH

“Translations of the original instructions”

INTRODUCTION

First of all we wish to thank you for choosing to use a **TECSYSTEM** product and recommend you read this instruction manual carefully: You will understand the use of the equipment and therefore be able to take advantage of all its functions.

ATTENTION! THIS MANUAL IS VALID AND COMPLETE FOR THE UNITS: NT511-NT511 MODBUS INSIDE - NT511 AD

CONTENTS

	PAGE
1) SAFETY REQUIREMENTS	4
2) ACCESSORIES	5
3) TECHNICAL SPECIFICATIONS	6
4) FRONT PANEL	8
• DISPLAY	9
• OPERATING PROGRAM CONTROL	—
• NOTES ON SCAN AND MAN FUNCTIONS	—
• LED TEST	—
• ALARM RELAY SILENCING	—
5) MOUNTING	—
6) ELECTRICAL CONNECTIONS	11
• POWER SUPPLY	13
• ALARMS AND VENTILATION	—
7) PROGRAMMING	14
• PROGRAMMING NOTES	16
• TEMPERATURE SENSORS	—
• MEASUREMENT SIGNAL TRANSFER	—
• TEMPERATURE SENSOR DIAGNOSTICS	17
• PROGRAMMED DATA DIAGNOSTICS	—
• TEMPERATURE DIAGNOSTICS	—
• COOLING FAN CONTROL	—
• FAN TEST	—

	PAGE
8) RS485 MODBUS (only for NT511 Modbus or AD)	18
• INTRODUCTION TO THE MODBUS INSIDE MODULE	—
• OPERATING NOTES	—
• DATA TRANSMISSION ON MODBUS NETWORK	—
• RS485 ELECTRICAL CONNECTIONS	—
• DATA FRAME	—
• DATA PACKET	—
• FUNCTION CODE	19
• CODE 3(10).	—
• CODE 16(10).	—
• NOTES FOR REMOTE PROGRAMMING	—
• ERROR CODES	20
• POLLING FREQUENCY	—
• MODBUS MAPPING TABLE	—
• CRC CALCULATION	24
• PARAMETER DESCRIPTION	—
• ALGORITHM	—
9) OUTPUT 4.20mA (only for NT511 AD)	—
10) TECHNICAL SPECIFICATIONS OF THE EXTENSION CABLE FOR Pt100	—
11) FCD FUNCTION	25
12) WARRANTY CONDITIONS	—
13) TROUBLESHOOTING	26
14) EQUIPMENT DISPOSAL	—
15) USEFUL CONTACTS	—

SAFETY REQUIREMENTS



ATTENTION:

Carefully read the manual before starting using the control unit. Keep the instructions for future reference.



Do not open the device, touching any internal component can result in electric shock as voltages over 50 volts can be lethal. In order to reduce the risk of electric shock, do not disassemble the back of the device. Warranty shall be void if device is opened.

Before connecting the device to the power supply, ensure that all the connections are correct. Always disconnect the unit from the supply before making any modification on the wiring.



Any operation on the equipment must be operated by a qualified technician.

Failure to comply with these instructions can cause damages, fires or electric shock, and possible serious injuries!

POWER SUPPLY

The NT511 series control unit has a power supply 230 Vac -50/60Hz.

Before use, ensure that the power cable is not damaged, knotted or pinched. Do not tamper with the power cable. Never disconnect the unit by pulling the cable, avoid touching the clamps. Do not carry out any connecting/disconnecting operation with wet hands. To disconnect the device, do not use objects such as levers. Immediately disconnect the device if you smell burning or see any smoke: contact technical service.

LIQUIDS

Do not expose the equipment to liquid spurts or drops, do not position it in places where humidity exceeds 90% and never touch it with wet or humid hands. If any liquid penetrates the control unit, disconnect immediately and contact technical service.

CLEANING

Disconnect the power cable before cleaning the control unit, using a dry cloth without any solvent or detergent, and compressed air.

OBJECTS

Never insert objects into the openings of the control unit. If this happens, disconnect the control unit and contact technical service.

USE RESERVED TO QUALIFIED PERSONNEL

The purchased good is an advanced electronic device that should not be used by non-qualified personnel. Any operation must be carried out by a qualified technician.

ACCESSORIES

The use of non-original accessories or spare parts may damage the unit and endanger users' safety. In event of fault, contact technical service.

LOCATION

Install the control unit indoor, in a place protected from water splashes and sun rays. Do not place near heat sources if exceeding the parameters stated in this manual. Position on a stable surface, far from any possible vibrations. Position the unit as far as possible from intense magnetic fields.

REPAIRS

For any fault, always use qualified personnel. Modifying of the unit boards generate the automatic forfeiture of the warranty.

TECHNICAL INFORMATION

Mail: ufficiotecnico@tecsystem.it — **tel:** 02/4581861

ACCESSORIES

The following object are present inside the box:

Control unit
Start guide and QR code

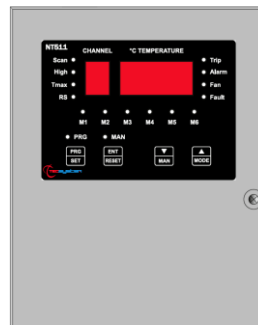

Start guide and QR code

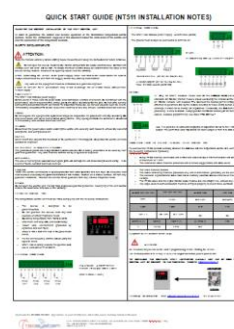

2 supply terminal and RS485 (*) 3 poles pitch 5
Code: 2PL0367 - Screws tightening torque 0.5Nm



1 relay terminal 9 poles pitch 5
Code: 2PL0376- Screws tightening torque 0.5Nm



1 relay terminal output M1 to M6 7 poles pitch 5
Code: 2PL0373- Screws tightening torque 0.5Nm



1 Pt100 sensor terminal 12 poles pitch 5
Code: 2PL0361- Screws tightening torque 0.5Nm



1 terminal 2 poles pitch 5 for 4.20mA output (*)
Code: 2PL0364 - Screws tightening torque 0.5Nm



(*) only for model option

**ATTENTION: always install the device using the terminals included in the pack.
The use of terminals other than those included with the control unit might cause malfunctions.**

TECHNICAL SPECIFICATIONS	NT511	NT511 MODBUS	NT511 AD
POWER SUPPLY			
Supply rated values	230VAC±10% 50/60Hz	230VAC±10% 50/60Hz	230VAC±10% 50/60Hz
Absorption (without fans)	6VA	6VA	6VA
INPUTS			
4 inputs for RTD sensors, Pt100 type with 3 wires (max section 2.5mm ²)	•	•	•
Connections on removable terminal strips	•	•	•
Input channels protected against electromagnetic interference	•	•	•
Cable compensation for thermistors	500 m (1 mm ²)	500 m (1 mm ²)	500 m (1 mm ²)
OUTPUTS			
2 alarm relays (ALARM AND TRIP) SPDT	•	•	•
1 sensor or operating failure (FAULT) relay SPDT	•	•	•
Output relays with 5 A-250Vac-res COSΦ=1 contacts.	•	•	•
6 outputs M1-M2-M3-M4-M5-M6 powered for fans (fuse 2A 250V)	•	•	•
Modbus RTU RS485 output	NO	•	•
4.20 mA output	NO	NO	•
DIMENSIONS			
210x263x89.5mm	Hole 182 x 232 mm	Hole 182 x 232 mm	Hole 182 x 232 mm
TESTS AND PERFORMANCE			
Construction in compliance with CE regulations	•	•	•
Protection from electrical interference EN 61000-4-4	•	•	•
Dielectric strength 1500 Vac for a min. between output relays and sensors, relays and power supply, power supply and sensors	•	•	•
Accuracy ±1% v/s, ±1 digit	•	•	•
Ambient operating temperature from -20°C to +60°C	•	•	•
Humidity 90% non-condensing	•	•	•

TECHNICAL SPECIFICATIONS	NT511	NT511 MODBUS	NT511 AD
Frontal film polycarbonate IP50	•	•	•
Steel painted housing	•	•	•
Digital linearity of sensor signal	•	•	•
Self-diagnostic circuit	•	•	•
Protection treatment of the electronic part	Option	Option	Option
DISPLAY AND DATA MANAGEMENT			
1 display to display temperatures and programming parameters (°C TEMPERATURE)	•	•	•
1 display for reference channel (CHANNEL)	•	•	•
3 leds indicating display mode (SCAN, HIGH, TMAX)	•	•	•
4 leds indicating alarm or trip channel (FAULT, FAN, ALARM, TRIP)	•	•	•
6 leds indicating motor status line (M1, M2, M3, M4, M5, M6)	•	•	•
Led indicating program mode (PRG)	•	•	•
1 led indicating manual mode fan operating (MAN)	•	•	•
1 led indicating modbus communication (RS485)	•	•	•
Temperature monitoring from 0°C to 200°C	•	•	•
2 alarm thresholds (alarm/trip) CH1-2-3	•	•	•
2 alarm thresholds (alarm/trip) CH4	•	•	•
2 ON-OFF thresholds for fan control	•	•	•
Access to programming through front keyboard	•	•	•
Sensors diagnostic (Fcc-Foc-Fcd)	•	•	•
Entering the programming by frontal push button	•	•	•
Incorrect programming warning	•	•	•
Storage of maximum temperatures reached by channels, alarm memory and sensor fault	•	•	•
Front key to reset the alarms	•	•	•

FRONT PANEL

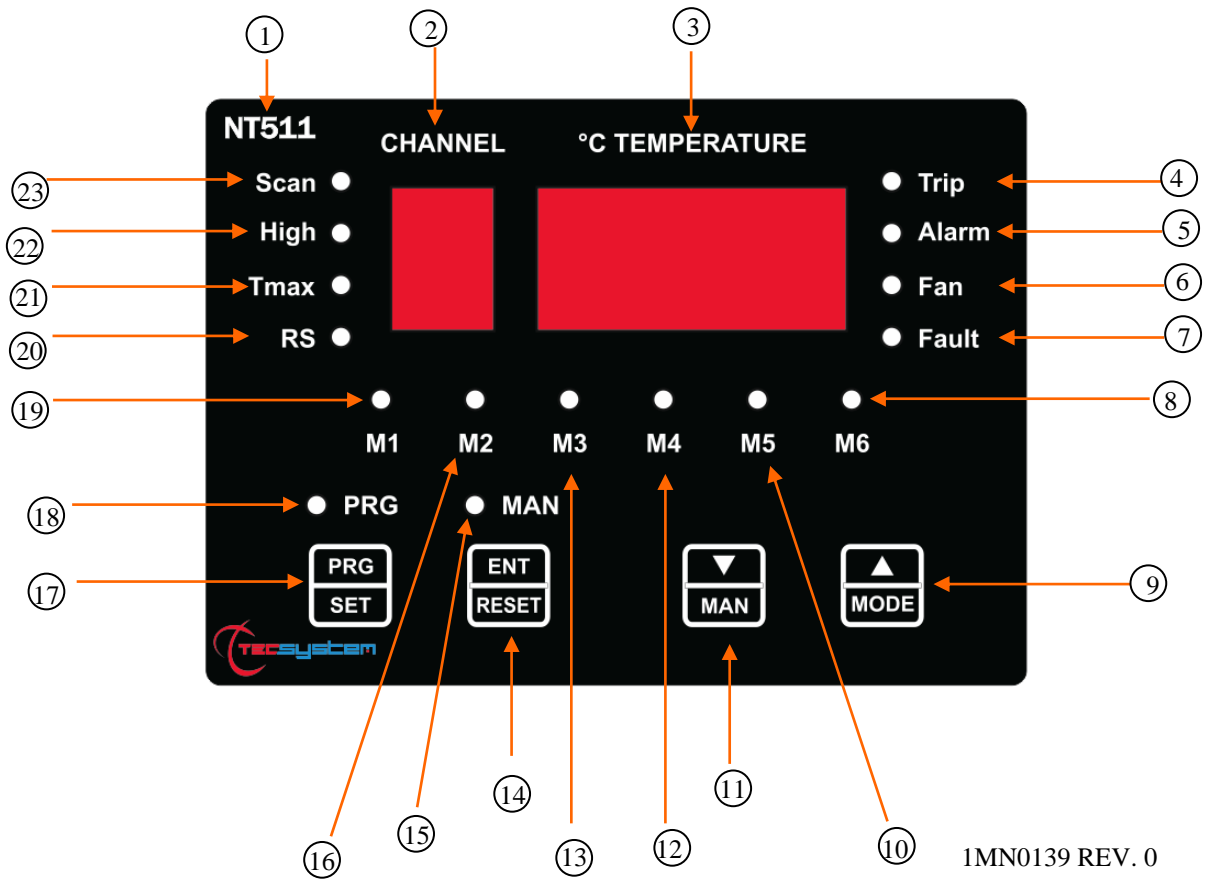

1MN0139 REV. 0

1)	Control unit series	13)	FAULT M3 (red) LED
2)	1-digit channel display (CHn)	14)	Enter/Reset button
3)	3-digits temperature display	15)	Manual mode fan operating (yellow) LED
4)	TRIP (red) LED	16)	FAULT M2 (red) LED
5)	ALARM (yellow) LED	17)	Programming / Setting key
6)	FAN (yellow) LED	18)	Entering PRG (yellow) LED
7)	FAULT (red) LED (UNIT)	19)	FAULT M1 (yellow) LED
8)	FAULT M6 (red) LED	20)	Modbus RS communication (green) LED (only NT511 Modbus Inside and AD)
9)	Mode selection key and UP key	21)	T-max mode selection (red) LED
10)	FAULT M5 (red) LED	22)	High mode selection (green) LED
11)	MAN selection key and DOWN key	23)	Scan mode selection (yellow) LED
12)	FAULT M4 (red) LED		

DISPLAY

The first display is dedicated to the monitored channel.

The second display to the temperatures.

Pressing the MODE key, the display modes can be set:

- **SCAN:** the monitoring unit displays all the activated channels scanning every 2 seconds.
- **HIGH:** the monitoring unit displays the hottest channel automatically.
- **T.MAX:** the monitoring unit displays the highest temperature reached by the sensors and any situation of: alarm or fault occurred after the last reset. Select channels with cursors ▲▼, reset values with RESET.

OPERATING PROGRAM CONTROL

To control the protection levels programmed, press the PRG key to access the **viS** display mode.

Indication viS will appear for 2 seconds, by repeatedly pressing the PRG key, you can scroll through all the previously loaded values in sequence.

After 1 minute's keyboard inactivity, the programming display procedure is automatically abandoned.

To stop the display, press the ENT key.

LED TEST

LAMP TEST is performed when the unit power on and at the end of displaying and programming parameters.

During lamp test all the displays turn on for 2 seconds.

ALARM RELAY SILENCING

If you want to silence the ALARM signal press the RESET key: the relay de-energises and the ALARM LED, which was fixed, will start flashing. Silencing is automatically disabled when the temperature goes below the ALARM threshold.

MOUNTING

Drill a 182 x 232 mm hole in the panel sheet.

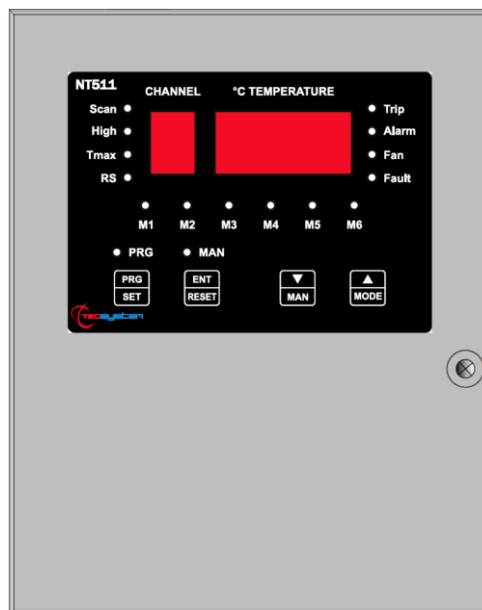

NT511 safety closure.
Open the door using a
screwdriver
#1X100mm

1MN 0138 REV. 0

Fix the unit securely with the screws.

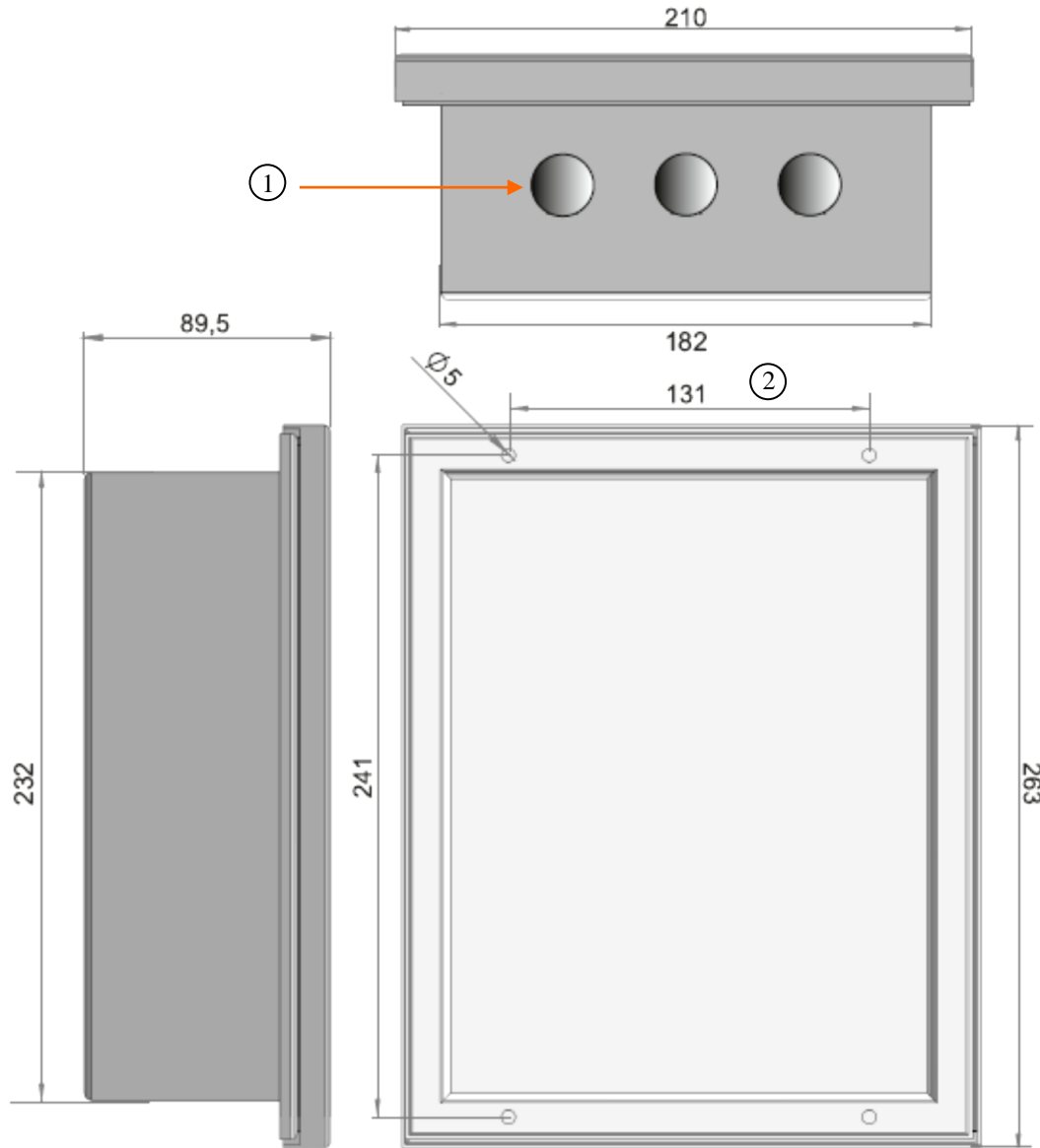

1MN 0138 REV. 0

1)	3 holes $\varnothing 22\text{mm}$ for electrical cable	2)	Dimensions and fixings
----	--	----	------------------------

ELECTRICAL CONNECTIONS

NT511 POWER-RELE' CARD

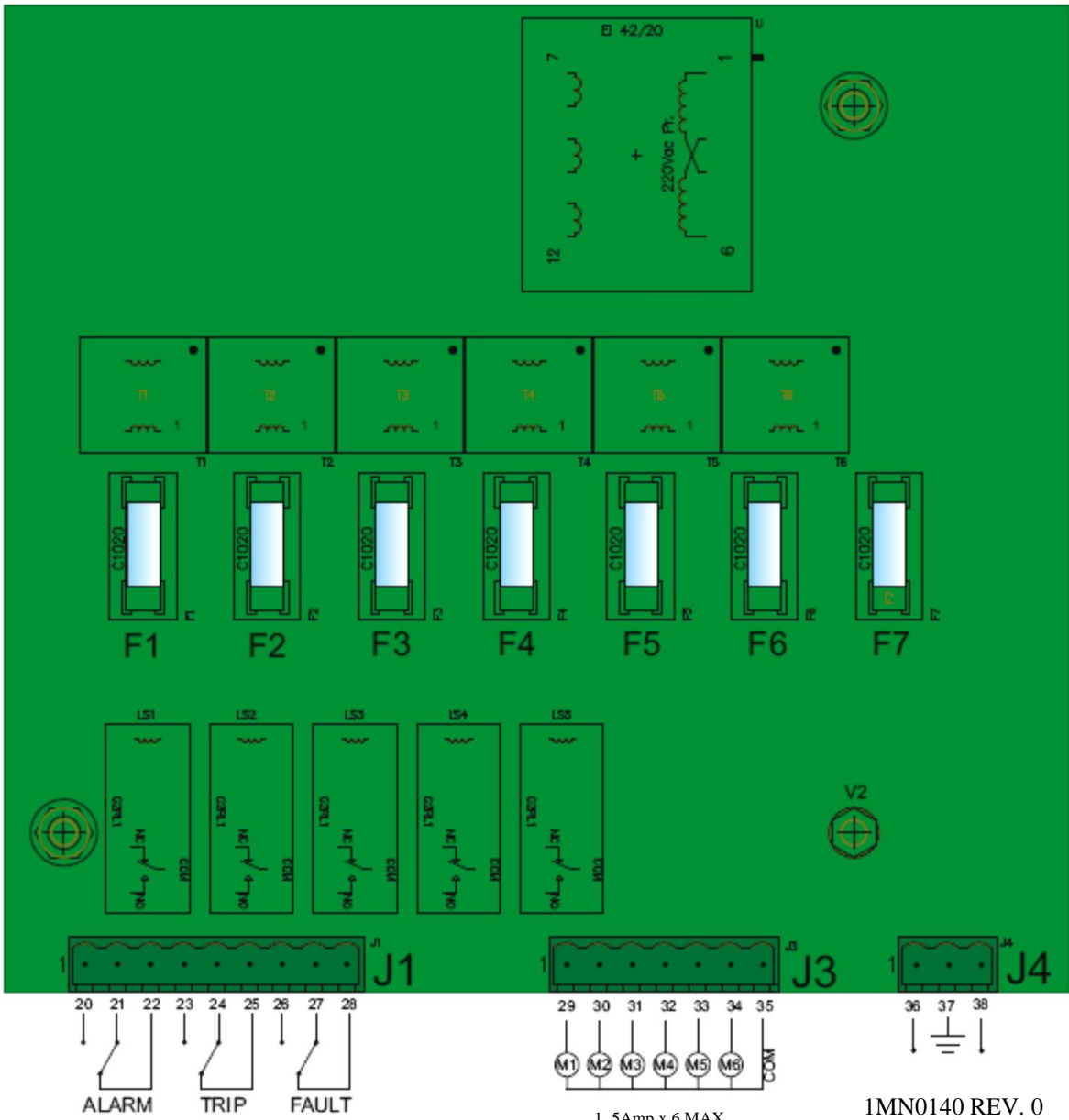

Output relay with 5A-250Vac-res $\text{COS}\Phi=1$ contacts.

1, 5Amp x 6 MAX

1MN0140 REV. 0

F1	2A 250V output M1 (5x20 fast) fuse	F6	2A 250V output M6 (5x20 fast) fuse
F2	2A 250V output M2 (5x20 fast) fuse	F7	Input power supply 0.5A 250V fuse
F3	2A 250V output M3 (5x20 fast) fuse	J1	Relè (ALARM-TRIP-FAULT).
F4	2A 250V output M4 (5x20 fast) fuse	J3	Motors outputs (M1-M2-M3-M4-M5-M6) 230Vac 50/60Hz.
F5	2A 250V output M5 (5x20 fast) fuse	J4	Power Supply 230Vac 50/60Hz

Note: relay contact image in non-alarm condition, with the exception of the FAULT relay that change his status: contacts 27-28 open (NO) contacts 26-28 closed (NC) fault condition identification. Read the Alarms and Ventilation paragraph on page 13 and see image of FAULT contact opening.

ELECTRICAL CONNECTIONS

NT511 CPU-DISPLAY CARD

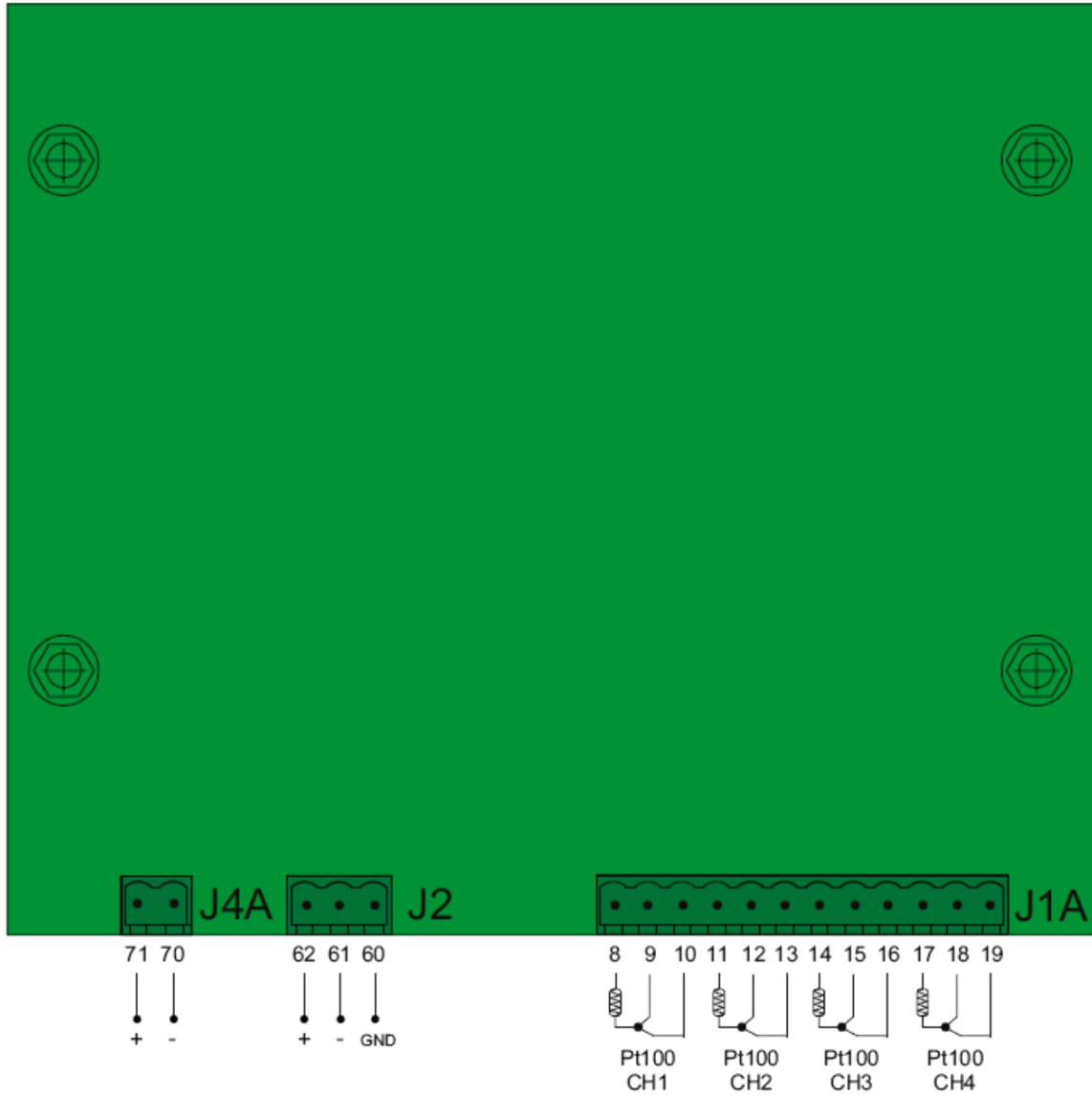

1MN0141 REV. 0

Pt100 CONNECTION EXAMPLE

J1A	Pt100 3 wires CH1-CH2-CH3-CH4 inputs
J2	RS485 Modbus RTU output (option)
J4A	4.20mA output (option)

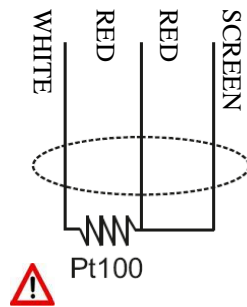

Note: before connecting the sensors to the control unit, read the Measurement signal transfer paragraph on page 16.

POWER SUPPLY

The NT511 control unit has 230Vac $\pm 10\%$ 50-60Hz power supply (terminal 36-38).

The ground must always be connected to terminal 37.

When the unit is supplied directly by the secondary of the transformer to protect, it can be burnt out by strong overvoltages.

This happens if the main switch is closed and the transformer has no load (blank test).

The above-mentioned problems are much more evident when the 230 Vac voltage is taken directly from the transformer secondary bars and there is a fixed capacitor battery to phase the transformer itself.

If an existing control unit must be replaced with a new one, to guarantee its correct and safe operation, the sensor/relay/supply connecting terminals must be replaced with the new terminals supplied.

ALARMS AND VENTILATION

Carry out the electrical connections on the removable terminal blocks only after disconnecting them from the unit.

When the control unit is in one of the modes mentioned below, it does not monitor the temperature and the relays are all blocked, the fault contact switches and the fault LED flashes.

- Vis. programming display
- PRG programming

The ALARM and TRIP relays switch only when the set temperature thresholds are exceeded.

The FAULT contact opens (27-28) when the equipment is supplied only if the unit detects no fault on switching on, and stays in this condition until one of the following events occurs:

- Data memory fault (Ech message).
- Pt100 sensor fault (FCC short-circuited sensor, FOC interrupted sensor or Fcd quick temperature increase)
- CAL damage to the measurement circuit.
- Insufficient supply voltage.
- During the power on reset after programming (PRG).

NOTE: do not connect the FAULT relay to the transformer tripping circuit to avoid unwanted system interruptions.

FAULT CONTACT OPERATION

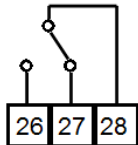

FAULT 27-28 NC: ALARM FAULT OR POWER OFF

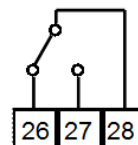

FAULT 27-28 NO: POWER ON OR NO FAULT

M1-2-3-4-5-6 outputs can be used to control the cooling fans (max 2A capacity), see paragraph Fan control on page 17.

NOTE: always disconnect the unit before performing any electrical connections.







































IMPORTANT WARNING

Before carrying out the isolation test of the electrical panel the control unit is installed on, disconnect it together with the sensors from the power supply to prevent it from being seriously damaged.

PROGRAMMING

NT511 MODBUS INSIDE /AD

STEP	PRESS	EFFECT	PRESS	NOTES
1		Keep the PRG key pressed until the display shows PRG, PRG led turns on		
2		The ALARM threshold for CH 1-2-3 is displayed Set the desired threshold, the Alarm LED flashes.		Default 90°C
3		The TRIP threshold for CH 1-2-3 is displayed and the Trip LED flashes.		
4		Set the desired threshold		Default 119°C
5		CH4 is displayed CH4 enabling		with YES CH4 is enabled with NO CH4 is disabled
6		Set YES or NO		Default NO
7		The ALARM threshold for CH4 is displayed, the Alarm LED flashes.		Default 120°C
8		Set the desired threshold		If CH4=NO go to step 11
9		The TRIP threshold for (CH4) is displayed, the Trip LED flashes.		Default 140°C
10		Set the desired threshold		
11		FAN is displayed and the Fan LED flashes.		Default CHF (CH1-CH2-CH3)
12		Set CHF (CH 1-2-3) / CHF (004) or NO		CHF (004) fan enabled on CH4. NO outputs FAN M1-M2-M3-M4-M5-M6 are disabled
13		Select M1-M2-M3-M4-M5-M6 fault indication outputs		Default M1-M2-M3-M4-M5-M6 active
14		FAN ON is displayed		
15		Set the desired threshold.		Default 70°C
16		FAN OFF is displayed		
17		Set the desired threshold.		Default 60°C

18		HFN (NO) is displayed The FAN1 LED flashes		Fan cyclic test for 5 min. every "n" hours
19		Set the desired number of hours		Default NO = function disabled
20		FCD (NO) is displayed		Fault for quick temperature increase (°C/sec)
21		Set the desired value (See FCD info on page 25)		Default NO (function excluded)
		For NT511 without options go to the step 30		
22		ADR <> "datum" is displayed		Modbus address Default 001
23		Set the address		From 1 to 255
24		BDR <> "datum" is displayed		Modbus transmission speed Default 19.2 Kb/s
25		Set the desired speed		From 2.4 Kb/s to 38.4 Kb/s
26		PAR <> "datum" is displayed		Parity bit selection Default EVE
27		Set the desired parity bit		None (No), Even (EVE), Odd (ODD)
		For NT511 Modbus Inside go to the step 30		
28		420 <> "datum" is displayed		4.20 mA output programming
29		Select the 4.20 mA output desired		1-2-3-4; fixed channel SCA: scanning HOT: the hottest channel Default HOT
30		END is displayed		END of programming
31		Press ENT to save the set data and exit programming		Err: incorrect programming of the LED values (note 4)
32		Return to step 1		See programming notes on page 16



ATTENTION:

We recommend you check the unit's programming before starting the device.

The default parameters set by TECSYSTEM might not match your requirements.

Programming the device is the end user's responsibility, the settings of the alarm thresholds and the enabling of the functions described in this manual must be checked (by a specialized engineer) according to the application and features of the system the control unit is installed on.

PROGRAMMING NOTES

- 1) After 1 minute's keyboard inactivity programming is abandoned without saving the data.
- 2) During programming the control unit does not control/protect the monitored machine.
- 3) At the end of programming the control unit is restarted and the FAULT relay is disabled until the unit is fully restarted.
- 4) If pressing ENT, "Err" appears, it means that one of the following mistakes has been made:

ERR ALL. = ALARM \geq TRIP
ERR FAN = FAN-OFF \geq FAN-ON

Press PRG to return to step 1 and correct the data.

TEMPERATURE SENSORS

Each Pt100 thermometric sensor has one white and two red connectors (CEI 75.8 regulations).
The CH2 channel must be always referred to the central column of the transformer.
The CH4 channel must be always referred either to the core of the transformer or to the Pt100 ambient sensor if you wish to thermo-regulate the transformer room using the NT511 control unit.

MEASUREMENT SIGNAL TRANSFER

All the cables transferring the Pt100 measurement signals must comply with the following under all circumstances:

1. Every Pt100 must be connected with a three-wire cable having a minimum section of 0.35mm² and a maximum of 1 mm².
2. The extension cable must be screened with tinned copper braid with an 80% cover
3. Conductors must be twisted, maximum recommended step 60mm
4. The cable screening must be grounded only with a termination, preferably on the unit side.
5. The sensors' signal transfer cable must not be near electrical cables, either low or medium-high voltage.
6. The Pt100 cable and the signal transfer cable must be laid in a straight line, without any winding.
7. Any caps used to butt conductors must be crimped properly to avoid false contacts.

NOTE: to install the sensors and signal transferring cable correctly, read the SCS/SENSOR installation rules manual.

What may happen when installation rules are not complied with.

- 1) The electrical field propagating from the power line of another circuit, couples capacitively with the conductors (in particular with unscreened cables). The effect of this coupling creates a signal that overlaps the signal transmitted by the nearby conductors, causing incorrect readings.
- 2) The variations in magnetic flux in the power lines may induce an electromotive force on the signal transferring cables (in particular non-twisted cables), that, being a closed circuit, generates a current. This interference current, multiplied by the circuit resistance, gives a voltage value that overlaps the signal to be transmitted, distorting the sensor measurement.
- 3) False contacts can alter the signal with the consequent variation in the temperature detected.

In specific cases, when the rules for connecting the Pt100 sensors are not complied with, the following anomalies can occur between the SCS box and the temperature control unit:

- a) incorrect temperature readings, alarms or anomalous tripping
- b) mechanical / electrical fault of the Pt100 sensors
- c) damage to the Pt100 inputs of the control unit.

TECSYSTEM S.r.l. has designed its own special cable to transfer the measurement signals, CEI-compliant, with all the protection requirements provided for: model **CT-ES**

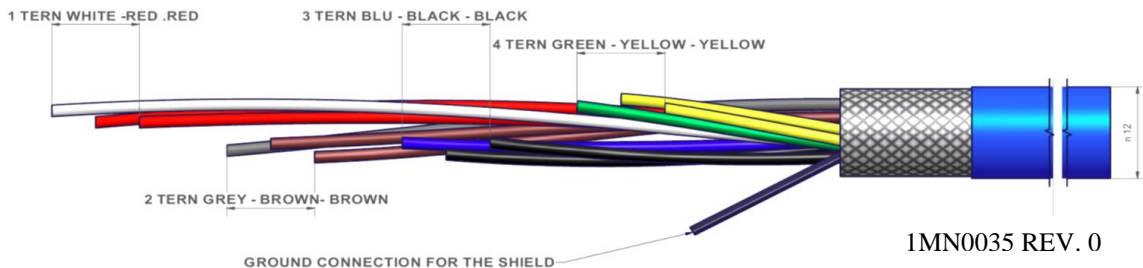

NOTE: the use of cables not complying with the above might cause reading anomalies. It is always important to take into account that any interference on the signal lines might cause anomalies on the Pt100 inputs (CH1-CH2-CH3-CH4) or on the sensors themselves.

All "NT" series control units have linearity of the sensor signal, with a maximum error of 1% of v_{fs}.

TEMPERATURE SENSOR DIAGNOSTICS

In case of failure or exceeded full scale value of one of the thermometric sensors installed on the machine to protect, the FAULT relay opens immediately with the relative warning of faulty sensor on the corresponding channel.

Fcc indicates sensor short-circuited or minimum full scale value of the control unit exceeded -20°C

Foc indicates sensor interrupted or maximum full scale value of the control unit exceeded 231°C

To eliminate the message and reset the opening of the Fault contact, it is necessary to check the Pt100 connections and replace the faulty sensor (if any). If the minimum/maximum full mscale value has been reached, check that the ambient conditions match the control unit reading.

Note: exceeding the minimum/maximum full scale value can also be caused by interference on the sensor lines; in this case we recommend that you check:

The correct installation of the sensors and above all of the extension cable (as stated in the paragraph MEASUREMENT SIGNAL TRANSFER).

The activation of FCD (see page 25) must always be operated taking into account the system working conditions.

CAL message display: it appears when damage is found in the measurement circuit. The temperature values displayed might be incorrect. Return the control unit to TECSYSTEM for repairs.

PROGRAMMED DATA DIAGNOSTICS

In case of failure of the internal memory or corruption of programmed data, just after switching on, **Ech** appears with the relevant Fault contact.

In this case, for safety reasons, the default parameters are loaded automatically (see programming table on pages 14-15).

Eliminate **Ech** by pressing RESET and run programming to enter the desired values.

Finally switch the unit off and back on to check the memory works correctly, if it is damaged **Ech** will be displayed again (send the control unit to TECSYSTEM srl for repairs).

TEMPERATURE DIAGNOSTICS

When one of the temperature sensors senses a temperature 1°C higher than the alarm threshold, 5 seconds later the **ALARM** relay switches and the *ALARM* LED of the affected channel (CH*n*) lights up.

When the trip temperature limit is exceeded, the **TRIP** relay switches and the *TRIP* LED of the affected channel (CH*n*) lights up.

As soon as the recorded temperature returns to values equal to or lower than the limit set for the **ALARM** and **TRIP** relays switching, these relays de-energise and the corresponding LEDs switch off.

The **ALARM** and **TRIP** values are kept in the internal memory: they can be recalled by entering the Vis modes (programmed parameter display) and modified in PRG (programming) mode.

COOLING FAN CONTROL

The NT511 control unit, if programmed correctly, can control the fans switching ON and OFF to cool the transformer.

The fans can be controlled in two different ways:

- Using the temperatures sensed by the sensors on the three columns
CHF 1.2.3
(ex. ON at 80°C - OFF at 70°C)
- Via an extra sensor (**CH4/YES**) dedicated to the ambient temperature inside the transformer room
CHF 4
(ex. ON at 40°C - OFF at 30°C)

The ON and OFF values can be programmed depending on the range of the device. FAN ON must always be at least 1 ° C above FAN OFF (recommended Δ FAN (ON_OFF) + 10 ° C).

The FAN LED lights up when the temperature exceeds the FAN ON threshold, the unit power up the outputs M1-1-2-3-4-5-6. When the temperature go under the FAN OFF threshold the unit power off the outputs M1-2-3-4-5-6, the led FAN switch off too.

The leds M1-2-3-4-5-6 (with indication enable) indicate the status of the FAN outputs: LED ON is broken fan or fuse F1-2-3-4-5-6 (we suggest to check the status of fuses and the fans). The LED OFF indicate the right working of the fans or the no activation of the fault line M1-2-3-4-5-6 (programming mode page 14 step 13).



MAN selection forced fan key allows you to: manually start the active fan outputs M1-M2-M3-M4-M5-M6. The manual activation is indicated when MAN led is ON.

FAN TEST

By programming (**HF*n***), it is possible to have the fans operating 5 minutes every "*xxx*" hours, regardless of the column or ambient temperature values (i.e.: with HF*n*=001 the fans are activated for 5 minutes every hour). This function aims at verifying the fan operation and their control apparatus periodically.

By setting HF*n* **NO** this function is inhibited.

To enable the HF*n* function, read the programming section on pages 14-15.

RS485 MODBUS OUTPUT

(ONLY FOR NT511 MODBUS AND AD)

INTRODUCTION TO THE MODBUS INSIDE MODULE

The MODBUS INSIDE expansion module is built in the monitoring unit and allows data transfer on a RS485 line with MODBUS RTU protocol, max 32 devices.

OPERATING NOTES

For the module to work correctly, it is necessary to set the RS485 network set-up parameters: address, baud rate, parity bit. See programming steps 22 to 27 on page 15.

The serial communication of the temperature control monitoring unit is active only when the NT511 is in temperature control mode in one of the intended modes (Scan, High and T.Max).

When other functions such as programming, programming display and relay test are activated, the ModBus communication is temporarily deactivated.

DATA TRANSMISSION ON MODBUS NETWORK

The MODBUS INSIDE internal module allows connecting the NT511 control unit to an RS485 network with Modbus RTU protocol in order to read the data shown in the MODBUS table on page 20 and write those in the notes for remote programming; the module is always in slave mode.

The NT511 Modbus or AD control unit is in communication with the network only when it is in temperature reading mode, while it is inactive when in the following modes: display, programming and relay test.

RS485 ELECTRICAL CONNECTIONS

As far as the signal cable to be used in order to ensure the correct network operation is concerned, we recommend you follow the provisions of the EIA RS485 standard which suggests using a 24AWG twisted pair.

The twisted pair that connects units in RS485 might need a 120 ohm end resistor on the last unit of the series.

Connect the twisted pair paying attention to polarities and lay the network avoiding to make sharp bends or ring windings in order not to modify line impedance. If necessary, the GND terminal for grounding is also available.

Always position the RS485 twisted pair far from power cables.

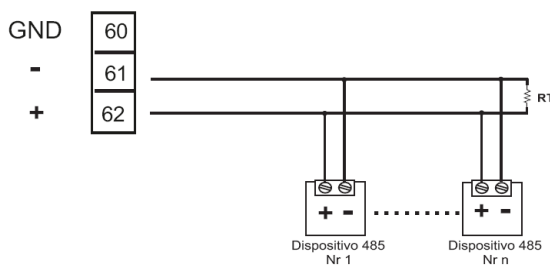

1MN0095 REV. 0

DATA FRAME

The frame in asynchronous transmission consists of: 1 start bit, 8 data bits, 1 parity bit (even or odd, if the parity has been set) and 1 stop bit.

Admitted baud rates are: 2400, 4800, 9600, 19200 and 38400.

If not otherwise specified, the word length (DATA) is 16 bits.

DATA PACKET

A complete sequence of request/answer consists of the following:

Master request:

SLAVE ADDRESS	- 1 byte
FUNCTION CODE	- 1 byte
DATA	- variable, it depends on the function code
CRC	- 2 bytes

Slave answer:

SLAVE ADDRESS	- 1 byte
FUNCTION CODE	- 1 byte
DATA	- variable, it depends on the function code
CRC	- 2 bytes

FUNCTION CODE

The ModBus module supports the following function codes:

3₍₁₀₎: - holding register reading

16₍₁₀₎: - register multiple writing

If ModBus receives a message and a CRC error is detected, no answer is given.

CODE 3₍₁₀₎

Request:

Slave address, code 3₍₁₀₎, Starting address HI, Starting address LO, Number of Point HI, Number of Point LO, Crc LO, Crc HI.

Answer:

Slave address, code 3₍₁₀₎, Byte count, Data HI, Data LO....., Crc LO, Crc HI.

CODE 16₍₁₀₎

Request:

Slave address, code 16₍₁₀₎, Starting address HI, Starting address LO, Number of Point HI, Number of Point LO, Byte count, Data HI, Data LO....., Crc LO, Crc HI.

Answer:

Slave address, code 16₍₁₀₎, Starting address HI, Starting address LO, Number of Register HI, Number of register LO, Crc LO, Crc HI.

The writable registers are those containing the following data: Alarm, Trip, Fan-on, Fan-off. The possible starting address are: **00-21** for alarm and trip thresholds, **00-29** for Fan-On /Off thresholds and **00-37** for optional that may be applicable to special unit models.

The parameter Number of Point LO can be set from 1 to 8 (max).

If a write request is sent to an address other than those mentioned above, ModBus will answer with an error code 02 (wrong data address).

If a write request is sent to a larger number of 8 registers (Number of point LO), ModBus will not be able to accept the request and will not give any answer, then the query will go in "timeout."

NOTES FOR REMOTE PROGRAMMING

If you want to program a NT511, you have to consider that Alarm settings of channels 1-2-3 (registers 00-21, 00-22, 00-23) must have the same values, because the control unit handles them as channels with common thresholds. The same note must be kept into consideration for Trip thresholds (registers 00-25, 00-26, 00-27).

Fan on thresholds (registers 00-29, 00-30, 00-31, 00-32) must be set with the same value.

Fan off thresholds (registers 00-33, 00-34, 00-35, 00-36) must be set with the same value.

Also in remote programming via ModBus you must take into consideration that the Alarm thresholds must be lower than the Trip thresholds and that the Fan-on thresholds must be higher than the Fan-off thresholds.

The Alarm and Trip thresholds are programmed together in the remote write operations, it will be considered as a single write lock the group of 8 addresses from 21 to 28.

The same applies to the of fan-on and fan-off thresholds: group of 8 addresses from 29 to 36.

If you try to set these thresholds wrongly, the NT511 monitoring unit won't proceed with programming and data storage; therefore in the following readings you will read the data relevant to the previous programming.

After sending a writing request, the monitoring unit will require approximately 1" to store the data in eeprom; during the storage phase, the ModBus module will not be able to process other requests.

If the programming request is successful, the control unit automatically resets and loads the newly set values.

ERROR CODES (exception codes)

In case of a wrong request, ModBus will answer with modified codes and codified errors according to the following:

- 1: - Unsupported function code
- 2: - Wrong data address
- 3: - Wrong data (for instance length)

POLLING FREQUENCY

We recommend polling frequencies equal to or greater than 1 second are adopted.
More frequent polling can overload the system without any benefit.

MODBUS MAPPING TABLE

Address	HI ₍₁₀₎	Address LO ₍₁₀₎	Data HI	Data LO	Primary tables	Note
00		01	00	Ch1 Temperature	Holding register	Range 0-200° Offset 20 ₍₁₀₎ 20=0°C 21=1°C 22=2°C
00		02	00	Ch2 Temperature	Holding register	
00		03	00	Ch3 Temperature	Holding register	
00		04	00	Ch4 Temperature	Holding register	
00		05	00	Ch1 State	Holding register	(See Note 1)
00		06	00	Ch2 State	Holding register	
00		07	00	Ch3 State	Holding register	
00		08	00	Ch4 State	Holding register	

Address HI ₍₁₀₎	Address LO ₍₁₀₎	Data HI	Data LO	Primary tables	Note
00	09	00	Setting Ch1	Holding register	(See note 2)
00	10	00	Setting Ch2	Holding register	
00	11	00	Setting Ch3	Holding register	
00	12	00	Setting Ch4	Holding register	
00	13	00	T. max Ch1	Holding register	Range 0-200° Offset 20 ₍₁₀₎ 20=0°C 21=1°C 22=2°C
00	14	00	T. max Ch2	Holding register	
00	15	00	T. max Ch3	Holding register	
00	16	00	T. max Ch4	Holding register	
00	17	00	Story Ch1	Holding register	(See note 3)
00	18	00	Story Ch2	Holding register	
00	19	00	Story Ch3	Holding register	
00	20	00	Story Ch4	Holding register	
00	21	00	Alarm Set-point Ch1	Holding register	Addresses from 21 to 28 are a single write lock
00	22	00	Alarm Set-point Ch2	Holding register	
00	23	00	Alarm Set-point Ch3	Holding register	
00	24	00	Alarm Set-point Ch4	Holding register	

Address (10)	HI	Address LO (10)	Data HI	Data LO	Primary tables	Note
00		25	00	Trip Set-point Ch1	Holding register	
00		26	00	Trip Set-point Ch2	Holding register	
00		27	00	Trip Set-point Ch3	Holding register	
00		28	00	Trip Set-point Ch4	Holding register	
00		29	00	Fan-On Set-point Ch1	Holding register	Addresses from 29 to 36 are a single write lock
00		30	00	Fan-On Set-point Ch2	Holding register	
00		31	00	Fan-On Set-point Ch3	Holding register	
00		32	00	Fan-On Set-point Ch4	Holding register	
00		33	00	Fan-Off Set-point Ch1	Holding register	
00		34	00	Fan-Off Set-point Ch2	Holding register	
00		35	00	Fan-Off Set-point Ch3	Holding register	
00		36	00	Fan-Off Set-point Ch4	Holding register	
00		37	00	Flag Generale	Holding register	(See note 4)
00		38	00	"Free"	Holding register	Free Register
00		39	00	HFN	Holding register	Hours test of cycle fan
00		40	00	SET_FCD	Holding register	FCD Setting

Address HI ⁽¹⁰⁾	Address LO ⁽¹⁰⁾	Data HI	Data LO	Primary tables	Note
00	41	00	4.20 output	Holding register	0=ch1, 1=ch2, 2=ch3, 3=ch4, 8=scan, 9=hot
00	42	00	NUM_CH	Holding register	Num. Enable Channels –1 ES: if N°=2 enable channels are 3
00	43	00	NUM_FAN	Holding register	Num. enable Fans
00	44	00	FAULT_FAN	Holding register	Faulty Fans

NOTE 1: STATUS REGISTER

The status register contains information about the status of the related alarm channel. Each bit represents a flag that is active when its value is 1.

B7	B6	B5	B4	B3	B2	B1	B0
TRIP	ALARM	FREE	FAN	FOC	FCC	FCD	FREE

NOTE 2: SETTING REGISTER

The setting register contains information about the setting of the related channel. Each bit represents a flag that is active when its value is 1.

B7	B6	B5	B4	B3	B2	B1	B0
FREE	FREE	FREE	FREE	FREE	FREE	FAN-EN	CH-EN

B0: the channel is enabled.

B1: the fan of the related channel is enabled.

NOTE 3: HISTORICAL ALARM REGISTER

The historical alarm register contains information about the storage of the related channel alarm interventions. Each bit represents a flag that is active when its value is 1.

B7	B6	B5	B4	B3	B2	B1	B0
TRIP	ALARM	FREE	FAN	FOC	FCC	FREE	FREE

NOTE 4: FLAG GENERAL REGISTER

General register contains information about the enabling of general functions.

B7	B6	B5	B4	B3	B2	B1	B0
FAN-MAN	RESET OK	ERRORE CAL	WRITE EEPROM	ECH	CICLO FAN	RESET ALL.	SEGNO -

B0: indicates that the temperature displayed is lower than 0°C.

B1: indicates that is given a data of alarm reset.

B2: indicates that is in progress the cyclic switching on and off the fan (durata:5 min.)

B3: indicates writing error in eeprom.

B4: indicates that is in progress the storage of programming data in eeprom.

B5: indicates the presence of an error of calibration of the unit.

B6: indicates the calibration error has been resetted.

B7: indicates that the fans are all manually activated

NOTE 5: FLAG OF THE FAULTY FANS

Each bit represents a flag that is active when its value is 1.

B7	B6	B5	B4	B3	B2	B1	B0
FREE	FREE	FAN6 (M6)	FAN5 (M5)	FAN4 (M4)	FAN3 (M3)	FAN2 (M2)	FAN1 (M1)

When the flag is active it means that the fan, even if supplied, is not working because it does not detect the current flowing (presence of no-load voltage). It is assumed that the fan is faulty or improperly connected.

CRC CALCULATION

The protocol includes 2 CRC-16 bytes in each transmission. The characteristic polynomial (1100000000000101B) is used for the calculation and the result is "hung" at the end of the packet. The polynomial is used in reverse order with the most significant bit suppressed because useless for the purpose of the calculation.

PARAMETER DESCRIPTION

A - 16-bit registers
AL – A low part
AH – A high part
i,j - COUNTERS
(+) - EXCLUSIVE OR
Di - Datum of the «i»th of the packet
N - number of bytes in the packet excluded 2 of the CRC
G - Polynomial: 1010-0000-0000-0001
shr - shift to the right

ALGORITHM

- 1) 0xFFFF -> A
- 2) 0 -> i
- 3) 0 -> j
- 4) Di (+) AL -> AL
- 5) j +1 -> j
- 6) shr A
- 7) if carry then G (+) A -> A
- 8) if NOT j=8 then go to 5
- 9) i +1 -> i
- 10) if NOT i = N then go to 3
- 11) A -> in CRC (the result is in order L,H)

OUTPUT 4.20mA

ONLY FOR NT511 AD

It is possible to connect a displaying or acquisition device to the 4.20 mA output.
The permitted load impedance for the output is **from 0 to 500 ohm**.
The 4-20 mA signal is referred to the 0-200°C range with an accuracy of 1% of full scale value.

The 4-20 mA signal is referred to the programmed channel following steps 28-29 of the table on page 15.

1-2-3-4: the 4.20 mA output refers to the fixed channel that has been set.
SCAN: the 4.20 mA output automatically scans the active channels every 2 seconds
HOT: the 4.20 mA output automatically refers to the hottest channel among the active ones

For the range 0+200 the relation is: $I_{out} = (T/12,5) + 4$ (T=temperature in °C)

Note: if the 4.20 output is programmed on CH4 and this is disabled, the control unit will automatically set on HOT.

Example: range 0°C + 200°C:

If T=100°C $I_{out} = 100/12.5+4 = 12 \text{ mA } (\pm 0.2 \text{ mA})$

Note: We recommend you use a screened and twisted cable; connect the twisted pair taking polarities into account and lay the network avoiding narrow bends or ring windings. Always position the twisted pair far from power cables.

Pt100 EXTENSION CABLE TECHNICAL SPECIFICATIONS

1. Cable 20 x AWG 20/19 Cu/Sn
2. Section 0.55 mm²
3. Flame retardant insulation PVC105
4. CEI 20.35 IEC 332.1 regulations
5. Maximum operating temperature: 90°C
6. Conformation: 4 sets of three twisted and coloured conductors
7. Shield in Cu/Sn
8. Flame retardant PVC sheath
9. External diameter 12mm
10. Standard conformation in 100m coils

FCD FUNCTION

The NT series equipment boasts an innovative control function combined with the dynamic status of the Pt100 sensor.

Activating FCD, the control unit analyses the increase in temperature ΔT (*) recorded in a second (**°C/sec**).

Enabling the function, the user can select the value (ΔT) from a minimum of 1°C/sec to a maximum of 30°C/ sec. If the value sensed is higher than the value set by the user, the control unit inhibits the possible activation of the ALARM and TRIP alarms and switches the FAULT relay (26-27-28), displaying the message "**Fcd fault**".

Example: if we set the function to 5°C, FAULT will switch for FCD only if the control unit senses an increase in ΔT of over 5°C in a second on the monitored system.

Setting "no" disables the FCD function.

When a channel is in FAULT for FCD, the relative Alarm and Trip warnings are inhibited; therefore only the over-quick temperature increase is highlighted.

Press Reset to delete the FCD warnings on all channels and reset the FAULT relay.

Possible FCD applications

Identification of a possible induced interference on the Pt100 sensor line

If the installation instructions are not complied with (see page 16), any interference on the Pt100 sensor line can cause false readings or anomalous alarms.

Setting the FCD function in a temperature range of between 1°C and 10°C (5°C recommended), the effects caused by false readings can be suppressed and the alarm relay activation can be prevented, as shown above.

Corrective actions: check the installation of the sensor extension cable is in line with the instructions given in the paragraph on the measurement signal transfer on page 16.

Identification of a sensor fault or faulty connection

In case of a faulty connection or sensor fault, a quick positive or negative variation in temperature might occur, leading to the system tripping or the alarms of the monitored system to be triggered.

In this specific case we recommend the FCD function to be set in a temperature range of between 10°C and 20°C.

Corrective actions: check the terminals the sensor is connected to are tightened and replace the faulty sensor, if required.

Identification of the electrical motor rotor block

In case of temperature control of the electrical motors, the quick temperature increase might be due to a blocked rotor.

In this specific case we recommend the FCD function to be set in a temperature range of between 20°C and 30°C. This setting is recommended in order to prevent the FCD function from activating during motor startup, or where the ΔT /sec. increase varies quickly.

(*) The ΔT value shows the temperature range for each second.

WARRANTY CONDITIONS

The Product purchased is covered by the manufacturer's or seller's warranty at the terms and conditions set forth in the "Tecsystem s.r.l.'s General Conditions of Sale", available at www.tecsystem.it and / or in the purchase agreement.

The warranty is considered valid only when the product is damaged by causes attributable to TECSYSTEM srl, such as manufacturing or components defects.

The warranty is invalid if the Product proves to have been tampered with / modified, incorrectly connected, because of voltages outside the limits, non-compliance with the assembly and use technical data, as described in this instruction manual.

The warranty is always ex Corsico as stated in the "General Conditions of Sale".

TROUBLESHOOTING	CAUSES AND SOLUTIONS
The control unit does not switch on and the supply to terminals 36-38 is correct.	Check that: the connector is correctly inserted into its housing, the wires are tightened, there is no evidence of burning on the connectors. Disconnect the power supply, carry out the above and reconnect.
CH4 is in FAULT because of FOC (only the 3 Pt100 sensors are connected)	Programming error of the CH4 / YES control unit. <i>Check and repeat programming as per page 14-15, select CH4 / NO.</i>
One of the three/four channels is in FAULT due to FOC/FCC	Check the connections of the Pt100 sensors, check the instructions given in the paragraphs: <i>measurement signal transfer and temperature sensor diagnostics on page 16-17.</i>
When turning on, the display shows "ECH"	Strong interference has damaged the stored data. See the paragraph Programmed data diagnostics on page 17.
All the PT100 sensors are in FCC.	Incorrect sensor connection, the terminal block has been inserted upside down. <i>Check the connections and the terminal board.</i>
The temperature shown by one or more channels is wrong.	Contact the <i>TECSYSTEM Technical Department.</i>
Sudden trip of the main switch. The temperature is on standard levels. Just one channel has caused the trip.	Check the temperatures recorded in T-MAX, check the instructions given in the paragraphs: <i>measurement signal transfer and temperature sensor diagnostics on page 17. Activate the FCD function.</i>
FCD warning	See the FCD function on page 25.
Contact <i>TECSYSTEM Technical Department</i> if the problem persists.	

EQUIPMENT DISPOSAL

European directive 2012/19/EU (WEEE) has been approved to reduce electrical and electronic waste and promote the recycling and reuse of the materials and components of said equipment, cutting down on the disposal of the residues and harmful components of electrical and electronic materials.



All the electrical and electronic equipment supplied after 13 August 2005 is marked with this symbol, pursuant to European directive 2012/19/EU on electrical and electronic waste (WEEE). Any electrical or electronic equipment marked with this symbol must be disposed of separately from normal domestic waste.

Returning used electrical devices: contact TECSYSTEM or your TECSYSTEM agent for information on the correct disposal of the devices.

TECSYSTEM is aware of the impact its products have on the environment and asks its customers active support in the correct and environmentally-friendly disposal of its devices.

USEFUL CONTACTS

TECHNICAL INFORMATION : ufficiotecnico@tecsystem.it

COMMERCIAL INFORMATION : info@tecsystem.it

