

# INSTRUCTION MANUAL

## NT538

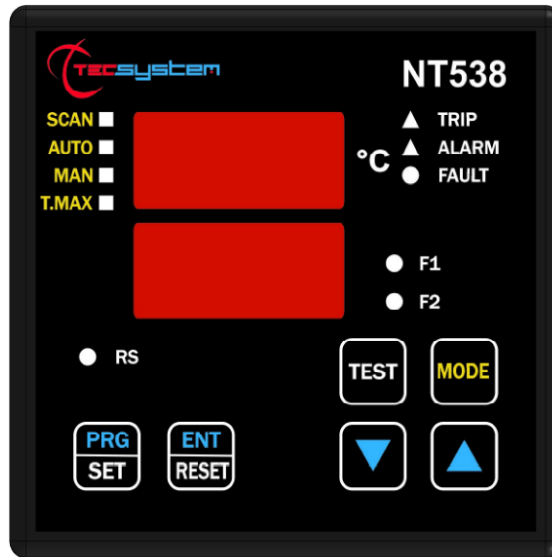

1MN0123 REV. 0



operates with ISO9001 certified quality system

**TECSYSTEM Shanghai Co.,Ltd**  
3rd Floor, Block No.5, No.33,Fuhua Road, Jiading  
District, Shanghai – China  
Tel.: +86 21 39905855/56/57  
Fax: +86 21 39905859

<http://www.tecsystem.asia>

R. 2.0 29/11/22

ENGLISH

## INTRODUCTION

First of all we wish to thank you for choosing to use a **TECSYSTEM** product and recommend you read this instruction manual carefully: You will understand the use of the equipment and therefore be able to take advantage of all its functions.

ATTENTION! THIS MANUAL IS VALID AND COMPLETE FOR THE CONTROL UNITS NT538 BASIC AND NT538 AD.

Special models available on request: NT538 CU10 (Copper 10Ohms at 25°C) BASIC and AD, NT538 AD Ni100 (ANSI) and NT538 AD Ni120 (ANSI) equipped with: three wires sensors, reading range -40 ° C to +200 ° C, FCC < -40°C and FOC > +200°C indications, lead compensation sensors 100 mt with 1mm<sup>2</sup> section cable.

**NOTE:** NT538 CU10 BASIC and AD version suitable with accuracy  $\pm 3\%$  full scale value,  $\pm 1$  digit.

## CONTENTS

	PAGE
1) SAFETY REQUIREMENTS .....	4
2) ACCESSORIES .....	5
3) TECHNICAL SPECIFICATIONS .....	6
4) FRONT PANEL .....	8
• DISPLAY .....	9
• OPERATING PROGRAM CONTROL .....	—
• NOTES ON SCAN AND MAN FUNCTIONS .....	—
• LED TEST .....	—
• ALARM RELAY TEST .....	—
• ALARM RELAY SILENCING .....	—
5) MOUNTING .....	10
6) NT538 BASIC ELECTRICAL CONNECTIONS .....	11
• NT538 AD ELECTRICAL CONNECTIONS .....	12
• POWER SUPPLY .....	13
• ALARMS AND VENTILATION .....	—
• FAULT AND RESET MESSAGE SEQUENCE .....	—
7) PROGRAMMING .....	14
• NT538 AD .....	—
• PROGRAMMING NOTES .....	16
• TEMPERATURE SENSORS .....	—
• MEASUREMENT SIGNAL TRANSFER .....	—
• TEMPERATURE SENSOR DIAGNOSTICS .....	17
• VOTING FUNCTION .....	—
• PROGRAMMED DATA DIAGNOSTICS .....	18
• TEMPERATURE DIAGNOSTICS .....	—
• COOLING FAN CONTROL .....	—
• FAN TEST .....	—

	PAGE
8) RS485 MODBUS (only AD) .....	19
• INTRODUCTION TO THE MODBUS INSIDE MODULE .....	—
• OPERATING NOTES .....	—
• DATA TRANSMISSION ON MODBUS NETWORK .....	—
• RS485 ELECTRICAL CONNECTIONS .....	—
• DATA FRAME .....	—
• DATA PACKET .....	—
• FUNCTION CODE .....	20
• CODE 3(10). .....	—
• CODE 16(10). .....	—
• NOTES FOR REMOTE PROGRAMMING .....	—
• ERROR CODES .....	21
• ILLEGAL DATA .....	—
• POLLING FREQUENCY .....	—
• MODBUS MAPPING TABLE .....	22
9) FAIL SAFE FUNCTION .....	27
10) OUTPUT 4.20mA (only AD) .....	—
11) Pt100 EXTENSION CABLE TECHNICAL SPECIFICATIONS .....	28
12) FCD FUNCTION .....	—
13) WARRANTY CONDITIONS .....	29
14) TROUBLESHOOTING .....	—
15) EQUIPMENT DISPOSAL .....	—
16) USEFUL CONTACTS .....	30
17) UL SPECIFICATION AND RATINGS .....	—

## SAFETY REQUIREMENTS



### ATTENTION :

Carefully read the manual before starting using the control unit. Keep the instructions for future reference.



Do not open the device, touching any internal component can result in electric shock as voltages over 50 volts can be lethal. In order to reduce the risk of electric shock, do not disassemble the back of the device. Warranty shall be void if device is opened.

**Before connecting the device to the power supply, ensure that all the connections are correct.** Always disconnect the unit from the supply before making any modification on the wiring.



Any operation on the equipment must be operated by a qualified technician.

**Failure to comply with these instructions can cause damages, fires or electric shock, and possible serious injuries!**

#### POWER SUPPLY

The NT538 control unit has UNIVERSAL power supply, i.e. it can be supplied from 24 to 240 Vac-Vdc, irrespectively of polarity in Vdc. Before use, ensure that the power cable is not damaged, knotted or pinched. Do not tamper with the power cable. Never disconnect the unit by pulling the cable, avoid touching the clamps. Do not carry out any connecting/disconnecting operation with wet hands. To disconnect the device, do not use objects such as levers. Immediately disconnect the device if you smell burning or see any smoke: contact technical service.

#### LIQUIDS

Do not expose the equipment to liquid spurts or drops, do not position it in places where humidity exceeds 90% and never touch it with wet or humid hands during storms. If any liquid penetrates the control unit, disconnect immediately and contact technical service.

#### CLEANING

Disconnect the power cable before cleaning the control unit, using a dry cloth without any solvent or detergent, and compressed air.

#### OBJECTS

Never insert objects into the openings of the control unit. If this happens, disconnect the control unit and contact technical service.

#### USE RESERVED TO QUALIFIED PERSONNEL

The purchased good is an advanced electronic device that should not be used by non-qualified personnel. Any operation must be carried out by a qualified technician.

#### ACCESSORIES

The use of non-original accessories or spare parts may damage the unit and endanger users' safety. In event of fault, contact technical service.

#### LOCATION

Install the control unit indoor, in a place protected from water splashes and sun rays. Do not place near heat sources if exceeding the parameters stated in this manual. Position on a stable surface, far from any possible vibrations. Position the unit as far as possible from intense magnetic fields..

#### REPAIRS

Do not open the control unit. In case of fault, always contact qualified personnel. The opening of the control unit and/or the removal of the series identifying label automatically make the warranty void. The warranty seal is applied to all devices, any attempt to open the unit would cause the seal to break the consequent automatic cancellation of the warranty.

#### FUNCTION

**To control the transformer correctly from a temperature point of view, enabling the VOTING function is allowed where the load distributed between the phases of the transformer is adequately balanced.**

#### TECHNICAL INFORMATION

Mail: [technical@tecsystem.asia](mailto:technical@tecsystem.asia) — tel: +86 21 39905855

# ACCESSORIES

The following object are present inside the box :

Control unit



INSTRUCTION MANUAL (CD)



2 blocks for panel mounting

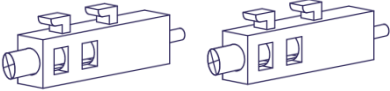

1 supply terminal 3 poles pitch 5  
Code: 2PL0367- Screws tightening torque 0.5Nm



1 relay terminal 12 poles pitch 5  
Code: 2PL0361 - Screws tightening torque 0.5Nm



2 Pt100 sensor terminal 12 poles pitch 3.81  
Code: 2PL0430 - Screws tightening torque 0.25Nm

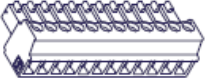

1 terminal 2 poles pitch 5 for 4.20mA output  
Code: 2PL0364 or 2PL0363 (\*)  
Screws tightening torque 0.5Nm



1 RS485 terminal 3 poles pitch 3.81  
Code: 2PL0366 (\*) - Screws tightening torque 0.25Nm



(\*) only for NT538 AD

**ATTENTION:** always install the device using the terminals included in the pack.  
The use of terminals other than those included with the control unit might cause malfunctions.

<b>TECHNICAL SPECIFICATIONS</b>	<b>NT538 BASIC</b>	<b>NT538 AD</b>
<b>POWER SUPPLY</b>		
Supply rated values	24-240 Vac-Vdc 50/60HZ	24-240 Vac-Vdc 50/60HZ
Maximum and minimum supply values	20-270 Vac-Vdc 50/60HZ	20-270 Vac-Vdc 50/60HZ
Vdc with reversible polarities	•	•
<b>INPUTS</b>		
8 inputs for RTD sensors, Pt100 type with 3 wires (max section 1.5mm <sup>2</sup> ) (Optional sensors CU10 –Ni100 –Ni120 see note on page 2)	•	•
Connections on removable terminal strips	•	•
Input channels protected against electromagnetic interference	•	•
Cable compensation for thermistors	500 m (1 mm <sup>2</sup> )	500 m (1 mm <sup>2</sup> )
<b>OUTPUTS</b>		
2 alarm relays (ALARM AND TRIP) SPDT	•	•
1 sensor or operating failure (FAULT) relay SPST	•	•
Output relays with 10A-250Vac-res COS $\Phi$ =1 contacts.	•	•
2 ventilation management relays SPST FAN 1 AND FAN 2	•	•
Modbus RTU RS485 output	NO	•
Optically isolated 4.20 mA output	NO	•
<b>DIMENSIONS</b>		
100x100 mm– din43700-depth 131mm (terminal block included)	Hole 92 x 92 mm	Hole 92 x 92 mm
<b>TESTS AND PERFORMANCE</b>		
Construction in compliance with CE regulations	•	•
Protection from electrical interference EN 61000-4-4	•	•
Dielectric strength 1500 Vac for a min. between output relays and sensors, relays and power supply, power supply and sensors	•	•
Accuracy $\pm$ 1% full scale value, $\pm$ 1 digit	•	•
Ambient operating temperature from –20°C to +60°C	•	•
Humidity 90% non-condensing	•	•

<b>TECHNICAL SPECIFICATIONS</b>	<b>NT538 BASIC</b>	<b>NT538 AD</b>
<b>TESTS AND PERFORMANCE</b>		
Frontal film polycarbonate IP65	•	•
Housing NORYL 94 _V0	•	•
Absorption 7,5VA	•	•
Data memory 10 years minimum	•	•
Digital linearity of sensor signal	•	•
Self-diagnostic circuit	•	•
Protection treatment of the electronic part	Option	Option
<b>DISPLAY AND DATA MANAGEMENT</b>		
2x13mm displays with 3 digits to display temperatures, messages and channels	•	•
3 LEDs to display the state of the alarms of the selected channel (ALARM-TRIP-FAULT)	•	•
2 LEDs to display the state of FAN1 and FAN2	•	•
Temperature control from 0°C to 240°C (*)	•	•
1 alarm thresholds for each channel	•	•
1 trip thresholds for each channel	•	•
2 ON-OFF thresholds for FAN 1 and FAN 2 in common for all enabled channels	•	•
Sensor diagnostics (Fcc-Foc-Fcd)	•	•
Data memory diagnostics (Ech)	•	•
Access to programming through front keyboard	•	•
Automatic exit from relay programming, display and test after 1 minute's inactivity	•	•
Incorrect programming warning	•	•
Selection between channel automatic scanning, hottest channel or manual scanning	•	•
Storage of maximum temperatures reached by channels and alarm status	•	•
Front key to reset the alarms	•	•
Voting function	•	•
(*) On demand, available version from -40°C to 200°C with alarm temperature management range from 0°C to 200°C		

# FRONT PANEL

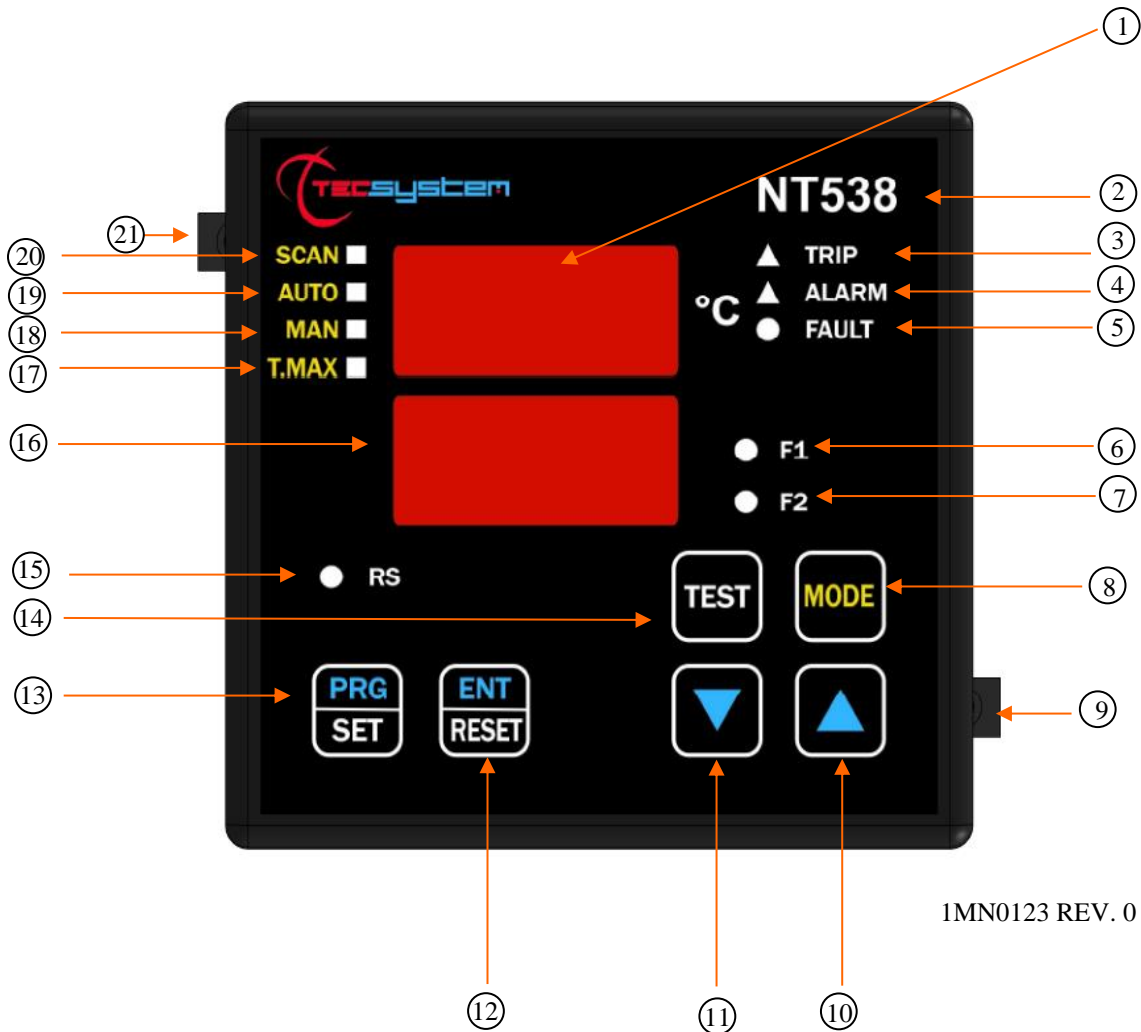

1MN0123 REV. 0

1)	3-digit temperature display	12)	Enter/Reset button
2)	Control unit series	13)	Programming / Setting key
3)	TRIP (red) LED	14)	LED/relay test key
4)	ALARM (yellow) LED	15)	Modbus RS communication (green) LED (only AD)
5)	FAULT (red) LED	16)	3-digit channel display
6)	FAN 1 (yellow) LED	17)	T-max mode selection (red) LED
7)	FAN 2 (yellow) LED	18)	Man mode selection (yellow) LED
8)	Display mode selection key	19)	Auto mode selection (green) LED
9)	Fixing block	20)	Scan mode selection (yellow) LED
10)	UP key	21)	Fixing block
11)	DOWN key		



## DISPLAY

*The first display is dedicated to temperatures.*

*The second display to the monitored channel.*

When switching the device ON or following a reset, the display shows: the NT538 control unit model BAS (no options) or AD, VER "00" (firmware version) and temperature range of the unit.

Pressing the MODE key, the display modes can be set:

- **SCAN:** the monitoring unit displays all the activated (°C) and deactivated (NO) channels scanning every 2 seconds.
- **AUTO:** the monitoring unit displays the hottest channel automatically.
- **MAN:** manual reading of the channel temperature using the up/down ▲▼.
- **T.MAX:** the monitoring unit displays the highest temperature reached by the sensors and any situation of: alarm or fault occurred after the last reset. Select channels with cursors ▲▼, reset values with RESET.

## OPERATING PROGRAM CONTROL

To control the protection levels programmed, press the PRG key twice to access the **VIS** display mode. By repeatedly pressing the PRG key, you can scroll through all the previously loaded values in sequence. After 1 minute's keyboard inactivity, the programming display procedure is automatically abandoned.

To stop the display, press the ENT key.

## NOTES ON SCAN AND MAN FUNCTIONS

During the SCAN and MAN modes, the operation of the NT538 can be displayed.

### 1) RUN cPU:

This message appears when the unit operates regularly without any system error.

### 2) Ech Err:

This message appears when a damage in the EEPROM memory is detected.

Pressing Reset will cancel the message and restore the original default parameters, listed in the programming paragraph on pages 13-14. Return the control unit to TECSYSTEM for repairs.

### 3) CAL Err:

This message appears when damage is found in the measurement circuit.

The temperature values displayed might be incorrect. Return the control unit to TECSYSTEM for repairs.

### 4) Pt Err :

This message appears when it is detected that one or more PT100 sensors are not working correctly, FOC, FCC and FCD indications in the temperature sensor diagnostics paragraph on page 17. In case of **Err** the FAULT relay will be de-energised.

The above messages will be displayed following the 1-2-3-4 priority stated.

**NOTE:** regardless of the display mode, in case of a sensor fault (fcc, foc or fcd), the control unit will automatically switch to **SCAN (PRIVILEGED SCAN)** mode, immediately allowing you to see the fault on the relative channel **CH**. (**Mode** key is disabled).

## LED TEST

We suggest carrying out the control unit LED test regularly.

For this operation, press the TEST key briefly; all the displays turn on for 2 seconds.

**If one of the LEDs does not work, please return the control unit to TECSYSTEM for repair.**

## ALARM RELAY TEST

This function allows you to carry out a test of the relay operation without having to use further devices. To start the test procedure, keep the TEST button pressed for about 5 seconds: TST appears for 2 seconds, confirming you have entered the Relay Test mode.

The LED that is lit shows the relay to be tested; use the cursors ▲▼ to select the desired relay.

Press the SET and RESET keys to energise and de-energise the relay to be tested; the display will show ON-OFF.

After 1 minute's keyboard inactivity, the RELAY TEST procedure will be automatically abandoned.

To stop the RELAY TEST procedure, press the TEST key.

Alternatively, you can use the PT100 simulator model: SIM PT100.

## ALARM RELAY SILENCING

If you want to silence the ALARM signal press the RESET key: the relay de-energises and the ALARM LED, which was fixed, will start flashing.

Silencing is automatically disabled when the temperature goes below the ALARM threshold.

## MOUNTING

Drill a 92 x 92 mm hole in the panel sheet.

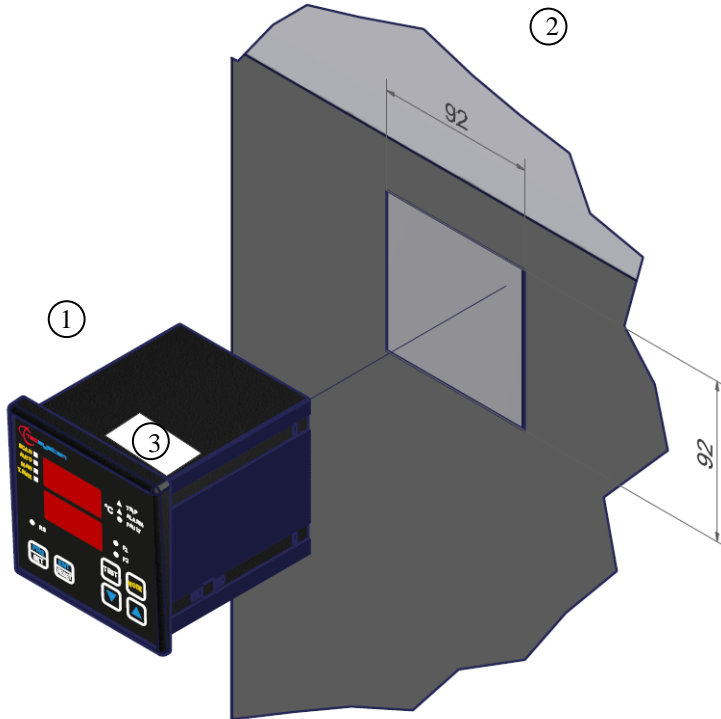

1MN0007 REV. 0

1)	Control unit	2)	Panel hole dimensions (+0.8mm tolerance)
3)	Identification label		

Fix the unit securely with the blocks supplied.

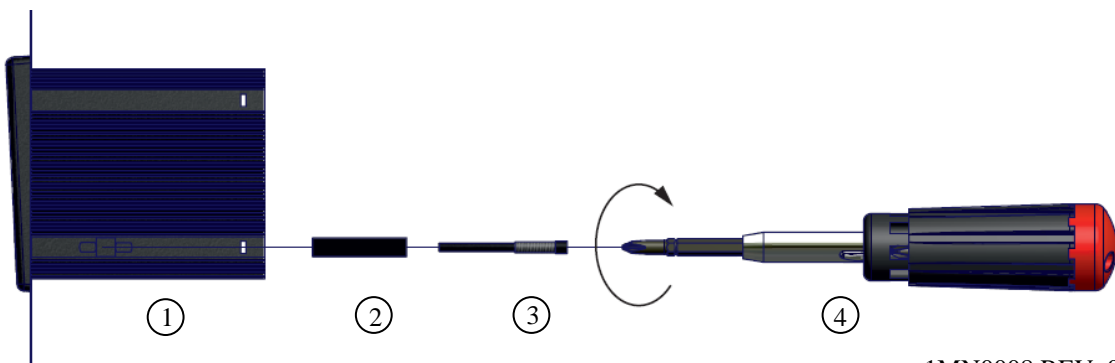

1MN0008 REV. 0

1)	Control unit	3)	Fixing screw
2)	Fixing block	4)	Crosshead screwdriver #1X100mm

# ELECTRICAL CONNECTIONS

NT538 BASIC

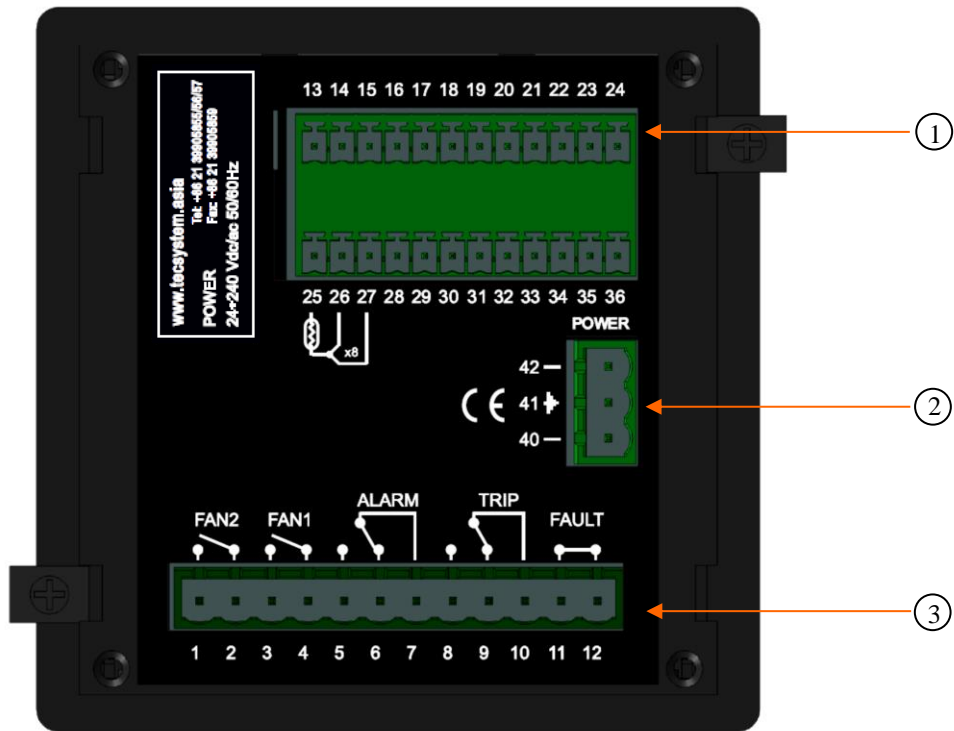

1MN0126 REV. 0

1)	Pt100 sensors (white-red-red)	3)	Relays (FAN2-FAN1-ALARM-TRIP-FAULT)
2)	Supply 24-240Vac-dc 50/60Hz.		

Note: relay contact image in non-alarm condition, with the exception of the FAULT relay that opens: contacts 11-12 open (NO) contacts 11-12 closed (NC) fault condition identification. Read the Alarms and Ventilation paragraph on page 13 and see the opening of the fault contact.

### RELAY CONNECTION EXAMPLE

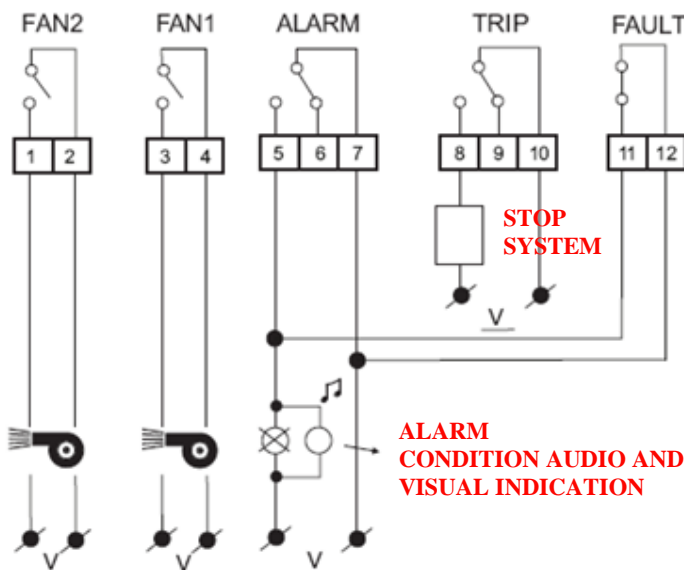

### Pt100 CONNECTION EXAMPLE

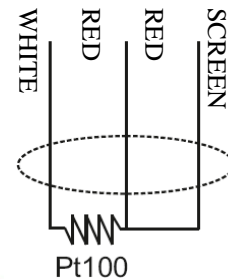

Note: before connecting the sensors to the control unit, read the Measurement signal transfer paragraph on page 16.

1MN0095 REV. 0

Output relay with 10A-250Vac-res  $\text{COS}\Phi=1$  contacts.

# ELECTRICAL CONNECTIONS

NT538 AD

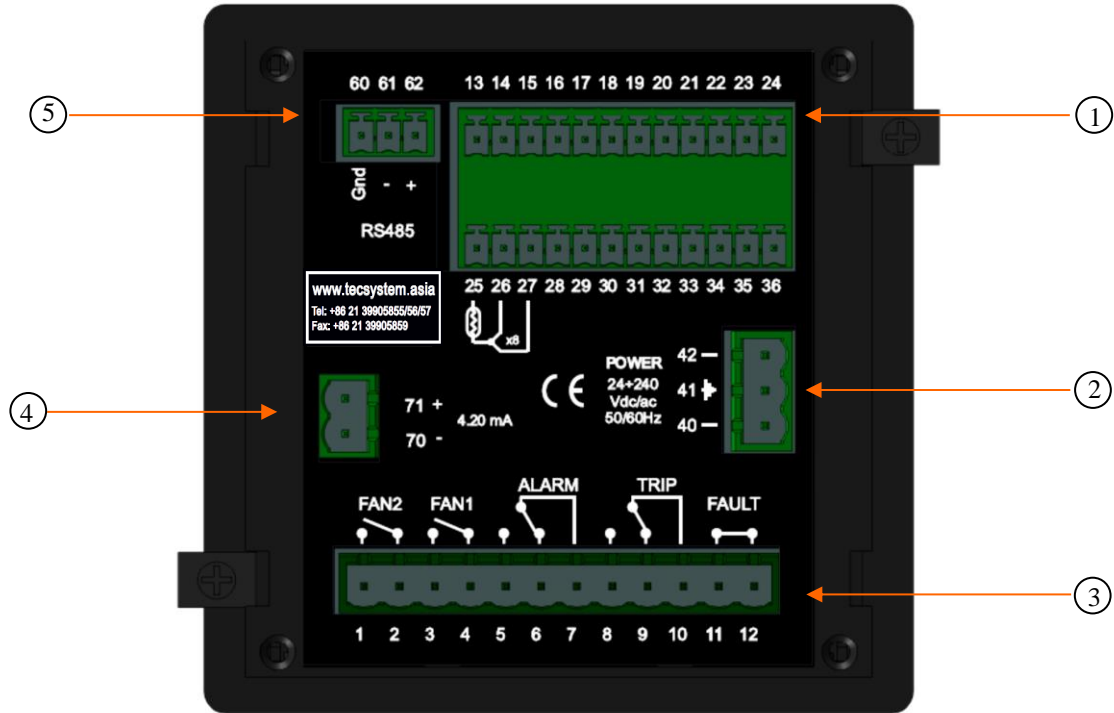

1MN0123 REV. 0

1)	Pt100 sensors (white-red-red)	3)	Relays (FAN2-FAN1-ALARM-TRIP-FAULT)
2)	Supply 24-240Vac-dc 50/60Hz.	4)	Output 4.20 mA
5)	Modbus RTU RS485 output		

Note: relay contact image in non-alarm condition, with the exception of the FAULT relay that opens: contacts 11-12 open (NO) contacts 11-12 closed (NC) fault condition identification. Read the Alarms and Ventilation paragraph on page 13 and see the opening of the fault contact.

## RELAY CONNECTION EXAMPLE

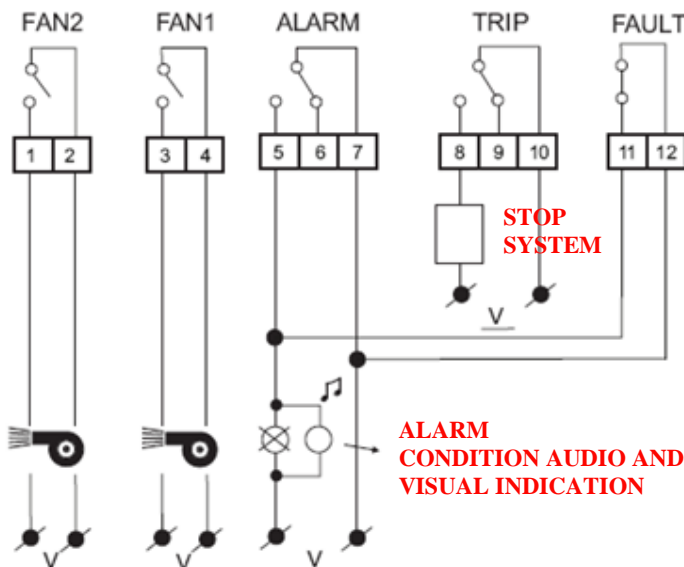

## Pt100 CONNECTION EXAMPLE

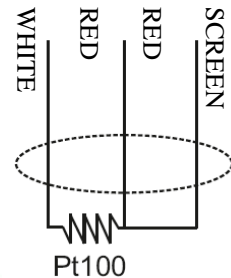

Note: before connecting the sensors to the control unit, read the Measurement signal transfer paragraph on page 16.

1MN0095 REV. 0

Output relay with 10A-250Vac-res  $\text{COS}\Phi=1$  contacts.

## POWER SUPPLY

The NT538 control unit has UNIVERSAL power supply, i.e. it can be supplied by 24 to 240 Vac-Vdc, 50/60Hz irrespectively of polarity in Vdc (terminals 40-42).

This is obtained thanks to the use of a tested power supply unit, newly designed and manufactured, that frees installers from worrying about the correct Vac and Vdc supply.

The ground must always be connected to terminal 41.

When the unit is supplied directly by the secondary of the transformer to protect, it can be burnt out by strong overvoltages.

This happens if the main switch is closed and the transformer has no load (blank test).

The above-mentioned problems are much more evident when the 220 Vac voltage is taken directly from the transformer secondary bars and there is a fixed capacitor battery to phase the transformer itself.

*To protect the control unit from line over voltages, we suggest using the PT-73-220 electronic discharger, designed by TECSYSTEM Shanghai for this specific purpose. As an alternative we suggest using 110 Vac or, even better, 110 Vdc supply voltages.*

**If an existing control unit must be replaced with a new one, to guarantee its correct and safe operation, the sensor/relay/supply connecting terminals must be replaced with the new terminals supplied.**

## ALARMS AND VENTILATION

Carry out the electrical connections on the removable terminal blocks only after disconnecting them from the unit.

When the control unit is in one of the modes mentioned below, it does not monitor the temperature and the relays are all blocked. The fault contact switches and the fault LED flashes.

- Vis. programming display
- PRG Programming
- Relay test

The ALARM and TRIP relays switch only when the set temperature thresholds are exceeded.

The FAULT contact opens (11-12) when the equipment is supplied only if the unit detects no fault on switching on, and stays in this condition until one of the following events occurs:

- Data memory fault (Ech message).
- Pt100 sensor fault (FCC short-circuited sensor, FOC interrupted sensor or Fcd quick temperature increase)
- CAL damage to the measurement circuit.
- Insufficient supply voltage.
- During the power on reset after programming (PRG), displaying the data (VIS) and test relay.

NOTE: do not connect the FAULT relay to the transformer tripping circuit to avoid unwanted system interruptions.

## FAULT CONTACT OPERATION

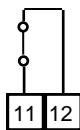

**FAULT 11-12 NC: ALARM FAULT OR POWER OFF**

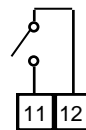

**FAULT 11-12 NO: POWER ON OR NO FAULT**

The FAN1 and FAN2 contacts can be used to control the cooling fans, or they can be inserted in the conditioning system of the transformer room, see paragraph Fan control on page 18.

NOTE: always disconnect the unit before performing any electrical connections.











## FAULT AND RESET MESSAGE SEQUENCE

Find below the sequence of fault messages and RESET function condition.

- |           |                            |                          |
|-----------|----------------------------|--------------------------|
| 1) ECH    | eeprom fault               | erasable message         |
| 2) CAL    | measurement circuit fault  | erasable message         |
| 3) FCD    | quick temp. increase fault | resettable condition     |
| 4) ERR PT | FCC or FOC sensor fault    | non-resettable condition |

# PROGRAMMING

## NT538 BASIC/AD

STEP	PRESS	EFFECT	PRESS	NOTES
1		Keep the PRG key pressed until the display shows PRG		
2		Press PRG to confirm entering programming mode		
3		CH1 is displayed CH1 activation		YES = CH1 Enable NO = CH1 Disable
4		Select YES or NO	 	
5		The ALARM threshold for (CH1) is displayed The Alarm LED flashes		Default 90°
6		Set the desired threshold	 	
7		The TRIP threshold for (CH1) is displayed The Trip LED flashes		Default 119°C
8		Set the desired threshold	 	
9		It is displayed the CH1 FAN activation, FAN1 and FAN2 are flashing		info functioning fans: fan cooling control section page 18
10		Select : YES: FAN1 - FAN2 enabled flashing YES only FAN1 enabled flashing YES only FAN2 enabled flashing NO LED FAN1 - FAN2 off	 	Default YES FAN1+FAN2
11		Repeat the above steps for all channels <b>CH2 - CH8</b>		
12		The display shows ON this indicator flashes FAN1		info functioning fans: fan cooling control section page 18
13		Set the desired threshold FAN1 ON	 	Default 70°C
14		The display shows OFF this indicator flashes FAN1		
15		Set the desired threshold FAN1 OFF	 	Default 60°C
16		The display shows ON this indicator flashes FAN2		
17		Set the desired threshold FAN2 ON	 	Default 45°C
18		he display shows OFF this indicator flashes FAN2		
19		Set the desired threshold FAN2 OFF	 	Default 30°C

20		HFN (NO) is displayed The FAN1-FAN2 LEDs flash		Fan cyclic test for 5 min. every "n" hours
21		Set the desired number of hours		Default NO = function disabled
22		FCD (NO) is displayed		Fault for quick temperature increase (°C/sec)
23		Set the desired value (See FCD info on page 28)		Default NO (function excluded)
24		VOT (NO) is displayed (See VOTING on page 17)		
25		Set NO-1-2-3		Default NO (function excluded)
26		The display shows FLS (ALARM) flashing LED ALARM (info FAIL SAFE on page 27)		
27		Set YES or NO		Default NO
28		The display shows FLS (TRIP) LED flashes TRIP		
29		Set YES or NO		Default NO
		FOR BASIC VERSION SKIP TO STEP 38		
30		ADR <> "datum" is displayed		Modbus address Default 001
31		Set the address		From 1 to 255
32		BDR <> "datum" is displayed		Modbus transmission speed Default 19.2 Kb/s
33		Set the desired speed		From 2.4 Kb/s to 38.4 Kb/s
34		PAR <> "datum" is displayed		Parity bit selection Default EVE
35		Set the desired parity bit		None (No), Even (EVE), Odd (ODD)
36		420 <> "datum" is displayed		4.20 mA output programming
37		Select the 4.20 mA output desired		1-2-3-4-5-6-7-8; fixed channel SCA: scanning HOT: the hottest channel Default HOT
38		END is displayed		End of programming
39		Press ENT to save the set data and exit programming		Err: incorrect programming of the LED values (note 6)
40		Return to step 1		See programming notes on page 16



**ATTENTION :**

We recommend you check the unit's programming before starting the device.

The default parameters set by TECSYSTEM might not match your requirements.

Programming the device is the end user's responsibility, the settings of the alarm thresholds and the enabling of the functions described in this manual must be checked (by a specialized engineer) according to the application and features of the system the control unit is installed on.

### PROGRAMMING NOTES

- 1) The MODE key allows reversing the programming steps according to the sequence 24-22-12-1.
- 2) The TEST key allows exiting programming without saving the modified data.
- 3) After 1 minute's keyboard inactivity programming is abandoned without saving the data.
- 4) During programming the control unit does not control/protect the monitored machine.
- 5) At the end of programming the control unit is restarted and the FAULT relay is disabled until the unit is fully restarted.
- 6) If pressing ENT, "Err" appears, it means that one of the following mistakes has been made:

ERR ALL. = ALARM  $\geq$  TRIP  
ERR FAN = FAN-OFF  $\geq$  FAN-ON. (FAN1 OR FAN2)

Press PRG to return to step 1 and correct the data.

**NOTE: EVERY TIME THE CONTROL UNIT IS PROGRAMMED WITH DATA SAVING CONFIRMATION, THE VALUES STORED IN T-MAX ARE RESET TO THE TIME OF SAVING.**

### TEMPERATURE SENSORS

Each Pt100 temperature sensor has a white wire and two red ( CEI 75.8 ) , in the figures on pages 11-12 shows the disposition of the in the terminal and connection cables. Each channel can be independently programmed with two alarm thresholds (alarm and trip ).

### MEASUREMENT SIGNAL TRANSFER

All the cables transferring the Pt100 measurement signals must comply with the following under all circumstances:

1. Every Pt100 must be connected with a three-wire cable having a minimum section of 0.35mm<sup>2</sup> and a maximum of 1 mm<sup>2</sup>.
2. The extension cable must be screened with tinned copper braid with an 80% cover
3. Conductors must be twisted, maximum recommended step 60mm
4. The cable screening must be grounded only with a termination, preferably on the unit side.
5. The sensors' signal transfer cable must not be near electrical cables, either low or medium-high voltage.
6. The Pt100 cable and the signal transfer cable must be laid in a straight line, without any winding.
7. Any caps used to butt conductors must be crimped properly to avoid false contacts.

**NOTE: to install the sensors and signal transferring cable correctly, read the sensor and SCS/SENSOR installation rules manual.**

**What may happen when installation rules are not complied with.**

1)The electrical field propagating from the power line of another circuit, couples capacitively with the conductors (in particular with unscreened cables). The effect of this coupling creates a signal that overlaps the signal transmitted by the nearby conductors, causing incorrect readings.

2) The variations in magnetic flux in the power lines may induce an electromotive force on the signal transferring cables (in particular non-twisted cables), that, being a closed circuit, generates a current. This interference current, multiplied by the circuit resistance, gives a voltage value that overlaps the signal to be transmitted, distorting the sensor measurement.

3) False contacts can alter the signal with the consequent variation in the temperature detected.

In specific cases, when the rules for connecting the Pt100 sensors are not complied with, the following anomalies can occur between the SCS box and the temperature control unit:

- a) incorrect temperature readings, alarms or anomalous tripping
- b) mechanical / electrical fault of the Pt100 sensors
- c) damage to the Pt100 inputs of the control unit.

TECSYSTEM Shanghai has designed its own special cable to transfer the measurement signals, CEI compliant, with all the protection requirements provided for model CT-ES

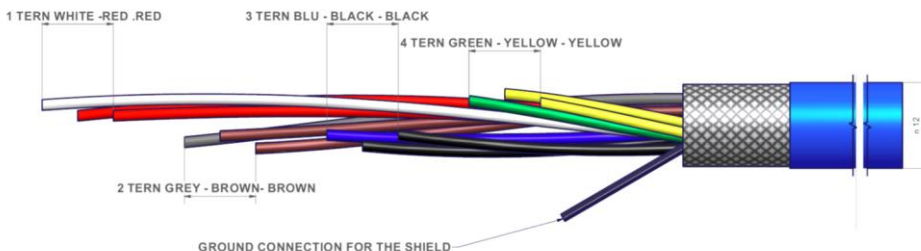

**NOTE:** the use of cables not complying with the above might cause reading anomalies. It is always important to take into account that any interference on the signal lines might cause anomalies on the Pt100 inputs (CH1-CH2-CH3-CH4-CH5-CH6-CH7-CH8) or on the sensors themselves.

All "NT" series control units have linearity of the sensor signal, with a maximum error of 1% of full scale value



**TEMPERATURE SENSOR DIAGNOSTICS**

In case of failure or exceeded full scale value of one of the thermometric sensors installed on the machine to protect, the FAULT relay opens immediately with the relative warning of faulty sensor on the corresponding channel (PT err).

Fcc indicates sensor short-circuited or minimum full scale value of the control unit exceeded -8°C (version 0°±240°C) and -48°C (version -40°C±200°C)

Foc indicates sensor interrupted or maximum full scale value of the control unit exceeded 243°C (version 0°±240°C) and 203°C (version -40°C±200°C)

To eliminate the message and reset the opening of the Fault contact, it is necessary to check the Pt100 connections and replace the faulty sensor (if any). If the minimum/maximum full scale value has been reached, check that the ambient conditions match the control unit reading.

Note: exceeding the minimum/maximum full scale value can also be caused by interference on the sensor lines; in this case we recommend that you check:

the correct installation of the sensors and above all of the extension cable (as stated in the paragraph MEASUREMENT SIGNAL TRANSFER)  
the activation of: VOTING (see below) or FCD (see page 28) must always be operated taking into account the system working conditions.

CAL message display: it appears when damage is found in the measurement circuit. The temperature values displayed might be incorrect. Return the control unit to TECSYSTEM for repairs.

**VOTING FUNCTION**

The voting function is derived from the concept of redundancy which consists of the duplication of components of a system with the intention of increasing **reliability**.

How the **VOTING** works?

Taking advantage of the principle indicated we use the probes installed to monitor the operation of the electrical machine, but at the same time ensure the proper functioning of the probes themselves, discriminating any false alarms (generated by installation errors or failures).

Enabling **VOTING** can be done by choosing one of three modes of selection "**1-2-3**" the control unit performs a comparison of the temperature values measured on the channels monitored, enables switching of the tripping contact (**TRIP**) only if it is found the overcoming of the TRIP threshold on at least two channels in the same period T.

Selecting **VOTING "NO"** function will be disabled.

In the tables, the selection, indicated below you will find the combination of channels with voting active available. For greater flexibility in two combination we expected channel with voting enabled and others with voting disabled.

- Voting enabled: The contact TRIP switches only if at least two channels exceeded TRIP threshold.
- Voting disabled: The contact switches when the TRIP single-channel exceeds the threshold of TRIP

Selection 1	Selection 2	Selection 3
VOTING ENABLE CH1.....CH3	VOTING ENABLE CH1 .... CH6	VOTING ENABLE CH1 .... CH8
1	1	1
2	2	2
3	3	3
VOTING DISABLE CH4..CH8	4	4
4	5	5
5	6	6
6	VOTING DISABLE CH7..CH8	7
7	7	8
8	8	

Note: The switching of **ALARM** signal still exceeded the threshold of alarm on each channel.

To enable Voting read the programming section on pages 14-15.



**Attention: To control the transformer correctly from a temperature point of view, enabling the VOTING function is allowed where the load distributed between the phases of the transformer is adequately balanced. In addition, any conditions of FAULT: FCC-FCC-FCD on two or more channels, with active voting, can determine the TRIP contact inhibition.**

### **PROGRAMMED DATA DIAGNOSTICS**

In case of failure of the internal memory or corruption of programmed data, just after switching on, **Ech** appears with the relevant Fault contact.

In this case, for safety reasons, the default parameters are loaded automatically (see programming table on pages 14-15). Eliminate **Ech** by pressing RESET and run programming to enter the desired values.

Finally switch the unit off and back on to check the memory works correctly, if it is damaged **Ech** will be displayed again (send the control unit to TECSYSTEM Shanghai for repairs).

### **TEMPERATURE DIAGNOSTICS**

When one of the temperature sensors senses a temperature 1°C higher than the alarm threshold, 5 seconds later the **ALARM** relay switches and the **ALARM** LED of the affected channel (CHn) lights up.

When the trip temperature limit is exceeded, the **TRIP** relay switches and the **TRIP** LED of the affected channel (CHn) lights up.

As soon as the recorded temperature returns to values equal to or lower than the limit set for the **ALARM** and **TRIP** relays switching, these relays de-energise and the corresponding LEDs switch off.

The **ALARM** and **TRIP** values are kept in the internal memory: they can be recalled by entering the Vis modes (programmed parameter display) and modified in PRG (programming) mode.

### **COOLING FAN CONTROL**

The unit NT538 has two contacts FAN (FAN1 and FAN2), if properly programmed, can control ON-OFF of fans for cooling system checked.

The high flexibility of the NT538 allows you to select, for each channel, an operation mode for contact management of FAN1 and FAN2. During the programming of the individual channel, enabled, you will be asked to select one of the following ways to activate FAN, dedicated to that channel:

- **YES: FAN1 + FAN2 enabled flashing**

The selected channel CHn, enable the switching of both contacts FAN1 and FAN2 in relation to thresholds ON - OFF programmed for FAN1 and FAN2.

- **YES only FAN1 enabled flashing**

The selected channel, CHn, enable the switching of the contact FAN1 in relation to the threshold ON - OFF programmed to FAN1.

- **YES only FAN2 enabled flashing**

The selected channel, CHn, enable the switching of the contact FAN2 in relation to the threshold ON - OFF programmed to FAN2.

- **NO: FAN1 + FAN2 flashing Off**

The FAN function on the selected channel, CHn, is disabled. The selected channel is not associated with any threshold FAN.

The thresholds FAN1: (ON – OFF) and FAN2: (ON – OFF) are common to all channels CHn enabled, programmable to step 12-19 Programming page 13.

**FAN1: (eg. At 70 ° C ON - OFF at 60 ° C)**

**FAN2: (eg. At 45 ° C ON - OFF at 35 ° C)**

The values of ON and OFF can be programmed depending on the range of the device, FAN ON must always be greater by at least 1 ° C since FAN OFF (recommended  $\Delta$  FAN (POWER ON-OFF) + 10 ° C

The FAN 1 / FAN 2 LED light up when the temperature exceeds 1°C the FAN ON threshold, the corresponding relay switches, and turns off when the temperature goes below 1°C the FAN OFF threshold, the corresponding relay switches.

### **FAN TEST**

By programming (**HFn**), it is possible to have the fans operating 5 minutes every "xxx" hours, regardless of the column or ambient temperature values (i.e.: with HFn=001 the fans are activated for 5 minutes every hour).

This function aims at verifying the fan operation and their control apparatus periodically.

By setting **NO** this function is inhibited.

To enable the Hfn function, read the programming section on pages 14-15.



### **IMPORTANT WARNING**

**Before carrying out the isolation test of the electrical panel the control unit is installed on, disconnect it together with the sensors from the power supply to prevent it from being seriously damaged.**

# RS485 MODBUS OUTPUT

## INTRODUCTION TO THE MODBUS INSIDE MODULE (ONLY FOR NT538 AD)

The MODBUS INSIDE expansion module is built in the monitoring unit and allows data transfer on a RS485 network with MODBUS RTU protocol.

### OPERATING NOTES

For the module to work correctly, it is necessary to set the RS485 network set-up parameters: address, baud rate, parity bit. See programming steps 30 to 35 on page 15.

The serial communication of the temperature control monitoring unit is active only when the NT538 AD is in temperature control mode in one of the intended modes (Scan, Auto, Man and T.Max).

When other functions such as programming, programming display and relay test are activated, the ModBus communication is temporarily deactivated.

### DATA TRANSMISSION ON MODBUS NETWORK

The MODBUS INSIDE internal module allows connecting the NT538 control unit to an RS485 network with Modbus RTU protocol in order to read the data shown in the MODBUS table on page 22 and write those in the notes for remote programming; the module is always in slave mode.

The NT538 AD control unit is in communication with the network only when it is in temperature reading mode, while it is inactive when in the following modes: display, programming and relay test.

### RS485 ELECTRICAL CONNECTIONS

As far as the signal cable to be used in order to ensure the correct network operation is concerned, we recommend you follow the provisions of the EIA RS485 standard which suggests using a 24AWG twisted pair.

The twisted pair that connects units in RS485 might need a 120 ohm end resistor on the last unit of the series.

Connect the twisted pair paying attention to polarities and lay the network avoiding to make sharp bends or ring windings in order not to modify line impedance. If necessary, the GND terminal for grounding is also available.

Always position the RS485 twisted pair far from power cables.

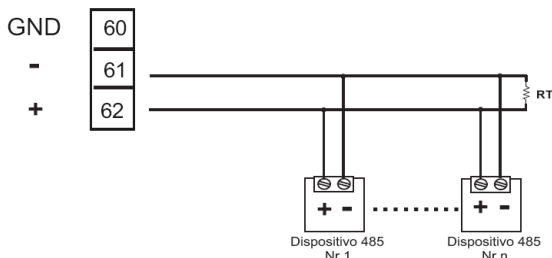

1MN0095 REV.0

### DATA FRAME

The frame in asynchronous transmission consists of: 1 start bit, 8 data bits, 1 parity bit (even or odd, if the parity has been set) and 1 stop bit.

Admitted baud rates are: 2400, 4800, 9600, 19200 and 38400.

If not otherwise specified, the word length (DATA) is 16 bits.

### DATA PACKET

A complete sequence of request/answer consists of the following:

Master request:

SLAVE ADDRESS	- 1 byte
FUNCTION CODE	- 1 byte
DATA	- variable, it depends on the function code
CRC	- 2 bytes

Slave answer:

SLAVE ADDRESS	- 1 byte
FUNCTION CODE	- 1 byte
DATA	- variable, it depends on the function code
CRC	- 2 bytes

## FUNCTION CODE

The ModBus module supports the following function codes:

**3<sub>(10)</sub>**: - holding register reading

**16<sub>(10)</sub>**: - register multiple writing

**If ModBus receives a message and a CRC error is detected, no answer is given.**

### CODE 3<sub>(10)</sub>

Request:

Slave address, code 3<sub>(10)</sub>, Starting address HI, Starting address LO, Number of Point HI, Number of Point LO, Crc LO, Crc HI.

Answer:

Slave address, code 3<sub>(10)</sub>, Byte count, Data HI, Data LO....., Crc LO, Crc HI.

### CODE 16<sub>(10)</sub>

Request:

Slave address, code 16<sub>(10)</sub>, Starting address HI, Starting address LO, Number of Point HI, Number of Point LO, Byte count, Data HI, Data LO....., Crc LO, Crc HI.

Answer:

Slave address, code 16<sub>(10)</sub>, Starting address HI, Starting address LO, Number of Register HI, Number of register LO, Crc LO, Crc HI.

## NOTES FOR REMOTE PROGRAMMING

The writable registers are shown in TABLE MODBUS MAPPING referred to as W or RW (**write or read / write**) max number of registers 72, see table page. 20.

In the case in which the channel is not enabled and / or the information is not provided we have the following answers:

- |                           |                                |
|---------------------------|--------------------------------|
| 1. Temperatures measured  | = 0000 (0 ° C)                 |
| 2. Temperatures AL. / TRP | = value written in E2PROM      |
| 3. Channel status         | = 0000                         |
| 4. Setting channel        | =% 00000000, xxxxxx0% (x = na) |

If WRITE data must always respect the rule T\_trip> T\_alarm and FAN\_ON> FAN\_OFF.

In case you try to set these thresholds incorrectly, the control unit NT538 will not proceed with the programming and storage of data, therefore in subsequent readings will read the data from the previous schedule.

After having sent a request for writing the control unit will take a time of about 1 to store the data in eeprom, during the step of storing the module ModBus will not be able to process additional requests

If the demand for programming is successful, the unit automatically resets and loads the new settings. In the event that information is sent in writing to a register can't be written (only READ) data will be trashed without affecting the received message.

If the information is sent to 4.20mA output = Chan\_4 and it is disabled it is forced mode HOT ; the same policy applies to programming from panel.

The information "RELAY STATUS" indicates the state of excitation of the coils of the relays, so it will be subject to the commands of "FAILS SAFE".

In the case of writing data "CPU SETTING" with bits "Failsafe Fault" = 0, it will be forced = 1 so as not to affect the validity of the data packet.

From the point of view of the control unit Modbus connection is considered as a normal NT538.

At the end of the write command (Write) is carried out a check of compatibility data:

- If you have a non-compatibility "exception" for an answer and the data packet is rejected in its entirety. The code of the first erroneous data can be obtained by reading the log "Error received data" (Note: this code is lost during RESET or new power or writing data in E2PROM);
- if the data are correct, they are transferred to the non-volatile memory (E2PROM), resets the historical data (Tmax = 0°C) and is subsequently forced a reset of the system
- If the WRITE command implies only writing "COMANDS" it will be implemented autonomously and without RESET, ie without affecting the data of the control unit.

### **ERROR CODES (exception codes)**

In case of a wrong request, ModBus will answer with modified codes and codified errors according to the following:

- 1: - Unsupported function code
- 2: - Wrong data address
- 3: - Wrong data (for instance length)

The memory area containing the HFN datum must undergo no forcing.

In the case in which all the fans are turned off (F1, F2) the test of the relay will not take place.

### **ILLEGAL DATA**

On the other hand, some combinations are programming errors because they are wrong settings; in this case the error code is ILLEGAL\_DATA. This information is accessible to ModBus reading the register 7.

NO ERROR	No error 00
CH_1 Trip ≤ Alarm	Code error 01
CH_2 Trip ≤ Alarm	Code error 02
CH_3 Trip ≤ Alarm	Code error 03
CH_4 Trip ≤ Alarm	Code error 04
CH_5 Trip ≤ Alarm	Code error 05
CH_6 Trip ≤ Alarm	Code error 06
CH_7 Trip ≤ Alarm	Code error 07
CH_8 Trip ≤ Alarm	Code error 08
FAN_1 ON ≤ OFF	Code error 017
FAN_2 ON ≤ OFF	Code error 018
No channels enabled	Code error 019
Value HFN > max see table: SYSTEM - Setting and Status	Code error 020
Value FCD > max see table: SYSTEM - Setting and Status	Code error 021
Value 4.20 > max see table: SYSTEM - Setting and Status	Code error 022
Value Voting > max see table: SYSTEM - Setting and Status	Code error 023
Voting wrong function ( channels not enabled)	Code error 024

Note. If the value of Voting is higher than the max value expected for the model in question, it will be set equal to "0", that is NO\_VOTING.

### **GENERAL UNIT NOTE**

The models of the unit can be equipped with different options ; to avoid disruption of production , their existence is defined by Fw indicated power , with messages dedicated on display LEDs .

This information can be accessed by reading the Modbus register 6 ( options ) with the following meaning :

#### **LOW Byte**

Bit\_0 = AD: 4.20mA + Modbus RS485

#### **HIGH Byte**

Bit\_0/1 = 00 - Range 0°C - 240°C  
Bit\_0/1 = 10 - Range -40°C ÷ +200°C  
Bit\_4/7 = 0000 – Pt100  
Bit\_4/7 = 0011 – CU10  
Bit\_4/7 = 0100 – Ni100  
Bit\_4/7 = 0101 – Ni120

In case of Ethernet option Modbus and 4.20mA mode shall not be active on the display. They will be readable from the log.

**Note: in case the values programmed from ModBus are out of range, it will generate a "expection" error response to date.**

### **POLLING FREQUENCY**

We recommend polling frequencies equal to or greater than 1 second are adopted.

More frequent polling can overload the system without any benefit whatsoever. In multi-device RS485 lines, interrogated in sequence, it may be useful to enter a delay between polls in relation to: the number of connected devices, the communication speed and the number of read registers.

## MODBUS MAPPING TABLE

### HEADER (information and commands):

Address LO <sup>(10)</sup>	Data HI	Data LO	R: read W:write RW: read/write
1	Model – MSD (ASCII)	Model - 3° Digit (ASCII)	R
2	Model - 2° Digit (ASCII)	Model – LSD (ASCII)	R
3	Space (20H)	Vers. Fw – MSD(ASCII)	R
4	Vers. Fw - 2° Digit (ASCII)	Vers. Fw – LSD(ASCII)	R
5	Channels qty (2*ASCII)		R
6	Options (see note)	Options (see note)	R
7	00	Wrong datum received	R-see tab.
8	00	Info various causes	R-see tab
9	00	Commands	W-see tab.

### SYSTEM: Setting and Status

Address LO <sup>(10)</sup>	Data HI	Data LO	Note 1	Note 2	R: read W:write RW: read/write
10	00	HFN (Fan test)	0=No test	1÷200h	RW
11	00	FCD	temperature increment	0=No FCD 1÷30°/sec	RW
12	00	Voting	0=No Voting	1-2-3	RW
13	00	CPU Setting	See Note		RW
14	00	CPU Error	See Note		R
15	00	Relays Status	See Note		R
16	00	420 mA channel	reference channel for 4.20 mA	0=hot 1÷8= ch1÷8 9 =scan	RW

17	00	Address	Modbus address	1÷255	R
18	00	Bdr	Modbus baud rate	0=2400 1=4800 2=9600 3=19200 4=38400	R
19	00	Parity	Modbus parity bit	0=No 1=Even 2=Odd	R
20	00	FREE	See Note		R

**TEMPERATURE FANS:**

Address LO <sub>(10)</sub>	Data HI	Data LO	Note 1	Note 2	R: read W:write RW: read/write
21	2'compl. sign	Fan_1 ON	1°C ÷ 240°C 1°C ÷ 200°C (*)		RW
22	2'compl. sign	Fan_1 OFF	1° to÷ 240° 1°C ÷ 200°C (*)		RW
23	2'compl. sign	Fan_2 ON	1° to÷ 240° 1°C ÷ 200°C (*)		RW
24	2'compl. sign	Fan_2 OFF	1° to÷ 240° 1°C ÷ 200°C(*)		RW

(\*) for version -40°C ÷ +200°C

**TEMPERATURES channels 1÷8:**

Address LO <sub>(10)</sub>	Data HI	Data LO	Note 1	Note 2	R: read W:write RW: read/write
25	2'compl. sign	2'compl. Ch1 temper.	-10°C ÷ 240°C -48°C ÷ 200°C (*)		R
26	2'compl. sign	2'compl. Ch1 max temperat.	0°C ÷ 240°C 0°C ÷ 200°C (*)		R
27	2'compl. sign	2'compl. Ch1 temper. alarm set point	1°C ÷ 240°C 1°C ÷ 200°C (*)	(AL)	RW
28	2'compl. sign	2'compl. Ch1 temper. trip set point	1°C ÷ 240°C 1°C ÷ 200°C (*)	(TRP)	RW
29	2'compl. sign	2'compl. Ch2 temper.	-10°C ÷ 240°C -48°C ÷ 200°C (*)		R
30	2'compl. sign	2'compl. Ch2 max temperat.	0°C ÷ 240°C 0°C ÷ 200°C (*)		R
31	2'compl. sign	2'compl. Ch2 temper. alarm set point	1°C ÷ 240°C 1°C ÷ 200°C (*)	As (AL)	RW
32	2'compl. sign	2'compl. Ch2 temper. trip set point	1°C ÷ 240°C 1°C ÷ 200°C (*)	As (TRP)	RW
33	2'compl. sign	2'compl. Ch3 temper.	-10°C ÷ 240°C -48°C ÷ 200°C (*)		R
34	2'compl. sign	2'compl. Ch3 max temperat.	0°C ÷ 240°C 0°C ÷ 200°C (*)		R

35	2'compl. sign	2'compl. Ch3 temper. alarm set point	1°C ÷ 240°C 1°C÷200°C (*)	As (AL)	RW
36	2'compl. sign	2'compl. Ch3 temper. trip set point	1°C ÷ 240°C 1°C÷200°C (*)	As (TRP)	RW
37	2'compl. sign	2'compl. Ch4 temper.	-10°C ÷ 240°C -48°C ÷200°C (*)		R
38	2'compl. sign	2'compl. Ch4 max temperat.	0°C ÷ 240°C 0°C÷200°C (*)		R
39	2'compl. sign	2'compl. Ch4 temper. alarm set point	1°C ÷ 240°C 1°C÷200°C (*)	As (AL)	RW
40	2'compl. sign	2'compl. Ch4 temper. trip set point	1°C ÷ 240°C 1°C÷200°C (*)	As (TRP)	RW
41	2'compl. sign	2'compl. Ch5 temper.	-10°C ÷ 240°C -48°C ÷200°C (*)		R
42	2'compl. sign	2'compl. Ch5 max temperat.	0°C ÷ 240°C 0°C÷200°C (*)		R
43	2'compl. sign	2'compl. Ch5 temper. alarm set point	1°C ÷ 240°C 1°C÷200°C (*)	As (AL)	RW
44	2'compl. sign	2'compl. Ch5 temper. trip set point	1°C ÷ 240°C 1°C÷200°C (*)	As (TRP)	RW
45	2'compl. sign	2'compl. Ch6 temperature	-10°C ÷ 240°C -48°C ÷200°C (*)		R
46	2'compl. sign	2'compl. Ch6 max temperat.	0°C ÷ 240°C 0°C÷200°C (*)		R
47	2'compl. sign	2'compl. Ch6 temper. alarm set point	1°C ÷ 240°C 1°C÷200°C (*)	As (AL)	RW
48	2'compl. sign	2'compl. Ch6 temper. trip set point	1°C ÷ 240°C 1°C÷200°C (*)	As (TRP)	RW
49	2'compl. sign	2'compl. Ch7 temper.	1°C ÷ 240°C 1°C÷200°C (*)		R
50	2'compl. sign	2'compl. Ch7 max temperat.	-10°C ÷ 240°C -48°C ÷200°C (*)		R
51	2'compl. sign	2'compl. Ch7 temper. alarm set point	0°C ÷ 240°C 0°C÷200°C (*)	As (AL)	RW
52	2'compl. sign	2'compl. Ch7 temper. trip set point	1°C ÷ 240°C 1°C÷200°C (*)	As (TRP)	RW
53	2'compl. sign	2'compl. Ch8 temper.	1°C ÷ 240°C 1°C÷200°C (*)		R
54	2'compl. sign	2'compl. Ch8 max temperat.	-10°C ÷ 240°C -48°C ÷200°C (*)		R
55	2'compl. sign	2'compl. Ch8 temper. alarm set point	0°C ÷ 240°C 0°C÷200°C (*)	As (AL)	RW
56	2'compl. sign	2'compl. Ch8 temper. trip set point	1°C ÷ 240°C 1°C÷200°C (*)	As (TRP)	RW

(\*) for version -40°C ÷ +200°C



**CHANNELs 1÷8: Setting**

Address LO (10)	Data HI	Data LO	Note 1	Note 2	R: read W:write RW: read/write
57	00	Ch1 Setting	See Note CHx		RW
58	00	Ch2 Setting	See Note CHx		RW
59	00	Ch3 Setting	See Note CHx		RW
60	00	Ch4 Setting	See Note CHx		RW
61	00	Ch5 Setting	See Note CHx		RW
62	00	Ch6 Setting	See Note CHx		RW
63	00	Ch7 Setting	See Note CHx		RW
64	00	Ch8 Setting	See Note CHx		RW

**CHANNELs 1÷8: Status**

Address LO (10)	Data HI	Data LO	Note 1	Note 2	R: read W:write RW: read/write
65	Ch1 story	Ch1 status	See Note CHx		R
66	Ch2 story	Ch2 status	See Note CHx		R
67	Ch3 story	Ch3 status	See Note CHx		R
68	Ch4 story	Ch4 status	See Note CHx		R
69	Ch5 story	Ch5 status	See Note CHx		R
70	Ch6 story	Ch6 status	See Note CHx		R
71	Ch7 story	Ch7 status	See Note CHx		R
72	Ch8 story	Ch8 status	See Note CHx		R

**INFO various causes (READ)**

BIT 7	BIT 6	BIT 5	BIT 4	BIT 3	BIT 2	BIT 1	BIT 0
--	--	--	-	-	-	-	(*) RESET (R) has taken place

**COMMANDS (WRITE)**

BIT 7	BIT 6	BIT 5	BIT 4	BIT 3	BIT 2	BIT 1	BIT 0
--	--	--	-	-	(*) Reset CPU_Error	(*) Reset historical data	(*) Zero. BIT: RESET has taken place

**CHn SETTING**

BIT 7	BIT 6	BIT 5	BIT 4	BIT 3	BIT 2	BIT 1	BIT 0
--	--	--	--	--	FAN2	FAN1	CAN_enabled

**CHn STATUS**

BIT 7	BIT 6	BIT 5	BIT 4	BIT 3	BIT 2	BIT 1	BIT 0
--	TRIP	ALARM	FAN_2	FAN_1	FCD	FOC	FCC

**CHn STORY**

BIT 7	BIT 6	BIT 5	BIT 4	BIT 3	BIT 2	BIT 1	BIT 0
--	TRIP	ALARM	--	--	--	FOC	FCC

**RELAY STATUS (coil energizing status)**

BIT 7	BIT 6	BIT 5	BIT 4	BIT 3	BIT 2	BIT 1	BIT 0
--	--	--	FAULT relay 1=No fault	TRIP relay 1=ON	ALARM relay 1=ON	FAN_2 relay 1=ON	FAN_1 relay 1=ON

**CPU ERROR**

BIT 7	BIT 6	BIT 5	BIT 4	BIT 3	BIT 2	BIT 1	BIT 0
--	--	--	--	PT ERROR	CAL	FCD Fault	ECH

**CPU SETTING**

BIT 7	BIT 6	BIT 5	BIT 4	BIT 3	BIT 2	BIT 1	BIT 0
--	--	--	Failsafe fault (always=1)	Failsafe trip	Failsafe alarm	--	--

## FAIL SAFE FUNCTION

The NT538 AD has n.o selection (contact open ) / n.c (normally closed contact) for alarm and trip relays, programming steps 26 to 29 page 15. The selection of the setting YES/NO introduces functions Fail Safe and No Fail Safe.

Setting YES (No Fail safe) normally open contacts are in positions 5-7 and 8-10 Alarm Trip, they switch only when limits are reached preset temperature.

By setting NO (Fail Safe) normally closed contacts are in positions 5-7 and 8-10 Alarm Trip, they switch only when limits are reached preset temperature.

NOTE: When the unit is located in one of the methods described below does not monitor heat, also the relay will all be banned:

- Vis. display programming.
- PRG programming.
- Test of the relays.

The FAIL SAFE is temporarily disabled The ALARM and TRIP relays switch.

## OUTPUT 4.20mA

**(ONLY FOR NT538 AD)**

It is possible to connect a displaying or acquisition device to the 4.20 mA output.  
The permitted load impedance for each output is from 0 to 500 ohm.  
The loop is optically isolated to guarantee the maximum immunity to interference.

The 4-20 mA signal is referred to the 0-240°C range with an accuracy of 1% of full scale value

The output can be programmed in the following modes:

**1-2-3-4-5-6-7-8:** the 4.20 mA output refers to the fixed channel that has been set.

**SCAN:** the 4.20 mA output automatically scans the active channels every 2 seconds  
(default setting)

**HOT:** the 4.20mA output automatically refers to the hottest channel among the active ones

See steps 36 - 37 of the table on page 15.

**Note: if the 4.20 output is programmed on CHn and this is disabled, the control unit will automatically set on HOT.**

**The current-temperature ratio varies according to the device temperature range:**

For the range 0°C + 240°C the ratio is:  $I_{out} = (T/15)+4$  (T=temperature in °C)  
For the range -40°C + 200°C the ratio is:  $I_{out} = (T/15)+6.7$  (T=temperature in °C)

**Example: range 0°C + 240°C:**

If T=100°C  $I_{out} = 100/15+4 = 10.67$  mA ( $\pm 0.2$  mA)

Note: We recommend you use a screened and twisted cable; connect the twisted pair taking polarities into account and lay the network avoiding narrow bends or ring windings. Always position the twisted pair far from power cables.

## Pt100 EXTENSION CABLE TECHNICAL SPECIFICATIONS

1. Cable 20 x AWG 20/19 Cu/Sn
2. Section 0.55 mm<sup>2</sup>
3. Flame retardant insulation PVC105
4. CEI 20.35 IEC 332.1 regulations
5. Maximum operating temperature: 90°C
6. Conformation: 4 sets of three twisted and coloured conductors
7. Shield in Cu/Sn
8. Flame retardant PVC sheath
9. External diameter 12mm
10. Standard conformation in 100m coils

## FCD FUNCTION

The NT series equipment boasts an innovative control function combined with the dynamic status of the Pt100 sensor.

Activating FCD, the control unit analyses the increase in temperature  $\Delta T$  (\*) recorded in a second (**°C/sec**).

Enabling the function, the user can select the value ( $\Delta T$ ) from a minimum of 1°C/sec to a maximum of 30°C/ sec. If the value sensed is higher than the value set by the user, the control unit inhibits the possible activation of the ALARM and TRIP alarms and switches the FAULT relay (11-12), displaying the message "**Fcd fault**".

Example: if we set the function to 5°C, FAULT will switch for FCD only if the control unit senses an increase in  $\Delta T$  of over 5°C in a second on the monitored system.

Setting "no" disables the FCD function.

When a channel is in FAULT for FCD, the relative Alarm and Trip warnings are inhibited on the single channel; therefore only the over-quick temperature increase is highlighted.

Press Reset to delete the FCD warnings on all channels and reset the FAULT relay.

### Possible FCD applications

#### Identification of a possible induced interference on the Pt100 sensor line

If the installation instructions are not complied with (see page 16), any interference on the Pt100 sensor line can cause false readings or anomalous alarms.

Setting the FCD function in a temperature range of between 1°C and 10°C (5°C recommended), the effects caused by false readings can be suppressed and the alarm relay activation can be prevented, as shown above.

Corrective actions: check the installation of the sensor extension cable is in line with the instructions given in the paragraph on the measurement signal transfer on page 16.

#### Identification of a sensor fault or faulty connection

In case of a faulty connection or sensor fault, a quick positive or negative variation in temperature might occur, leading to the system tripping or the alarms of the monitored system to be triggered.

In this specific case we recommend the FCD function to be set in a temperature range of between 10°C and 20°C.

Corrective actions: check the terminals the sensor is connected to are tightened and replace the faulty sensor, if required.

#### Identification of the electrical motor rotor block

In case of temperature control of the electrical motors, the quick temperature increase might be due to a blocked rotor.

In this specific case we recommend the FCD function to be set in a temperature range of between 20°C and 30°C. This setting is recommended in order to prevent the FCD function from activating during motor startup, or where the  $\Delta T$ /sec. increase varies quickly.

(\*) The  $\Delta T$  value shows the temperature range for each second.

**NOTE: you should not enable the FCD function with active VOTING.**

## WARRANTY CONDITIONS

The Product purchased is covered by the manufacturer's or seller's warranty at the terms and conditions set forth in the "Tecsystem Shanghai Co.,Ltd's General Conditions of Sale", available at [www.tecsystem.asia](http://www.tecsystem.asia) and / or in the purchase agreement.

The warranty is considered valid only when the product is damaged by causes attributable to TECSYSTEM shanghai Co.,Ltd, such as manufacturing or components defects.

The warranty is invalid if the Product proves to have been tampered with / modified, incorrectly connected, because of voltages outside the limits, non-compliance with the assembly and use technical data, as described in this instruction manual.

TROUBLESHOOTING	CAUSES AND SOLUTIONS
The control unit does not switch on and the supply to terminals 40-42 is correct.	Check that: the connector is correctly inserted into its housing, the wires are tightened, there is no evidence of burning on the connectors. Disconnect the power supply, carry out the above and reconnect.
FOC FAULT on CHn	Programming error of the CHn / YES control unit. <i>Check and repeat programming as per page 14-15, select CHn / NO.</i>
One of the three/four channels is in FAULT due to FOC/FCC	Check the connections of the Pt100 sensors, check the instructions given in the paragraphs: <i>measurement signal transfer and temperature sensor diagnostics on page 16-17.</i>
When turning on, the display shows "ECH"	Strong interference damaged the stored data. See the paragraph Programmed data diagnostics on page 18.
All the PT100 sensors are in FCC.	Incorrect sensor connection, the terminal block has been inserted upside down. <i>Check the connections and the terminal board.</i>
The temperature shown by one or more channels is wrong.	Contact the <i>TECSYSTEM Technical Department.</i>
Sudden trip of the main switch. The temperature is on standard levels. Just one channel has caused the trip.	Check the temperatures recorded in T-MAX, check the instructions given in the paragraphs: <i>measurement signal transfer and temperature sensor diagnostics on page 16. Activate the FCD function.</i>
FCD warning	See the FCD function on page 28.
Contact <i>TECSYSTEM Technical Department</i> if the problem persists.	

## EQUIPMENT DISPOSAL

European directives 2012/19/EC (WEEE) and 2011/65/EC (RoHS) have been approved to reduce electrical and electronic waste and promote the recycling and reuse of the materials and components of said equipment, cutting down on the disposal of the residues and harmful components of electrical and electronic materials.



All the electrical and electronic equipment supplied after 13 August 2005 is marked with this symbol, pursuant to European directive 2002/96/EEC on electrical and electronic waste (WEEE). Any electrical or electronic equipment marked with this symbol must be disposed of separately from normal domestic waste.

Returning used electrical devices: contact TECSYSTEM or your TECSYSTEM agent for information on the correct disposal of the devices.

TECSYSTEM is aware of the impact its products have on the environment and asks its customers active support in the correct and environmentally-friendly disposal of its devices.

## USEFUL CONTACTS

TECHNICAL INFORMATION: [technical@tecsystem.asia](mailto:technical@tecsystem.asia)

SALES INFORMATION: [chnsales@tecsystem.asia](mailto:chnsales@tecsystem.asia)  
[miawang@tecsystem.asia](mailto:miawang@tecsystem.asia)

## UL SPECIFICATION AND RATINGS

CABLE SPECIFICATION	Dimension for main circuit 18AWG, working temperature over 105 °C
MASS OF THE EQUIPMENT	0,45 Kg
INPUT SUPPLY	24 – 240 Vac / Vdc ( $\pm 10\%$ ), 50/60 Hz, 7,5VA max
PROTECTION	External switch or circuit breaker
OUTPUTS RELAYS	5 relay output: 10A 250Vac-res COS=1
OPTIONAL (AD)	RS485 e 4.20mA

Suitable for use on a flat surface of a type 1 enclosure if back panel is provided with two short fixing screws tightening torque : 0.57Nm