

INSTRUCTION MANUAL

T1048

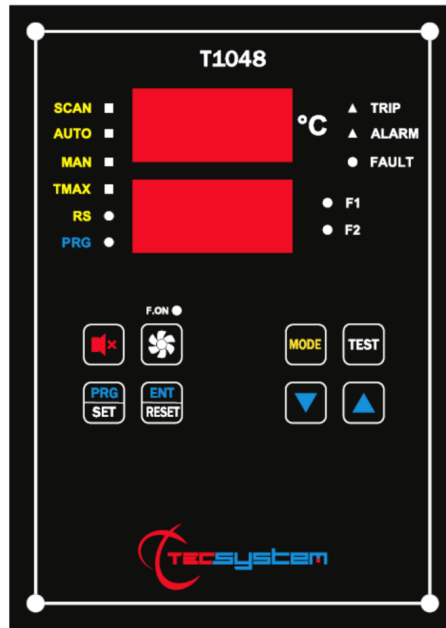

1MN0124 REV.0



operates with ISO9001 certified quality system

TECSYSTEM S.r.l.
20094 Corsico (MI)
Tel.: +39-024581861
Fax: +39-0248600783

<http://www.tecsystem.it>

R. 1.6 08/05/24

ENGLISH

“Translations of the original instructions”

INTRODUCTION

First of all we wish to thank you for choosing to use a **TECSYSTEM** product and recommend you read this instruction manual carefully: You will understand the use of the equipment and therefore be able to take advantage of all its functions.

ATTENTION! THIS MANUAL IS VALID AND COMPLETE FOR THE T1048 CONTROL UNITS

CONTENTS

	PAGE
1) SAFETY REQUIREMENTS	4
2) ACCESSORIES	5
3) TECHNICAL SPECIFICATIONS	6
4) FRONT PANEL	8
• DISPLAY	9
• OPERATING PROGRAM CONTROL	—
• NOTES ON SCAN AND MAN FUNCTIONS	—
• LED TEST	—
• ALARM RELAY TEST	—
• ALARM RELAY SILENCING	—
5) MOUNTING	10
6) ELECTRICAL CONNECTIONS	11
• T1048 BACK	—
• POWER SUPPLY	12
• ALARMS AND VENTILATION	—
• FAULT AND RESET MESSAGE SEQUENCE	—
7) PROGRAMMING	13
• T1048	—
• DEFAULT PROGRAMMING TABLES	15
• PROGRAMMING NOTES	—
• TEMPERATURE SENSORS	16
• MEASUREMENT SIGNAL TRANSFER	—
• TEMPERATURE SENSOR DIAGNOSTICS	17
• VOTING FUNCTION	—
• TEMPERATURE DIAGNOSTICS	—
• HYSTERESIS FUNCTION (RELAY ALARM AND TRIP)	—
• PROGRAMMED DATA DIAGNOSTICS	18
• COOLING FAN CONTROL	—
• FAN TEST	—
• INTELLIFAN FUNCTION	—

	PAGE
8) OPTIONAL OUTPUT	19
• INTRODUCTION TO THE RS485 MODULE	—
• OPERATING NOTES	—
• DATA TRANSMISSION	—
• NOTES ON RS485 ELECTRICAL CONNECTIONS	—
• DATA FRAME	—
• INTRODUCTION TO THE ETHERNET MODULE	—
• DATA TRANSMISSION	—
• OPERATING NOTES	20
• NOTES ON ETHERNET ELECTRICAL CONNECTIONS	—
• FUNCTION CODE	—
• CODE 3(10).	—
• CODE 16(10).	—
• NOTES FOR REMOTE PROGRAMMING	—
• ERROR CODES	21
• ILLEGAL DATA	—
• POLLING FREQUENCY	—
• MODBUS MAPPING TABLE	22
9) ETHERNET MODULE PARAMETER PROGRAMMING	27
• ETH0 CONNECTIONS	—
• TELNET ENABLING	—
• TELNET SCREEN	28
• IP PARAMETER PROGRAMMING MENU	29
10) FUNCTION FAILSAFE	31
11) Pt100 EXTENSION CABLE TECHNICAL SPECIFICATIONS	32
12) FCD FUNCTION	—
13) WARRANTY CONDITIONS	33
14) TROUBLESHOOTING	—
15) EQUIPMENT DISPOSAL	34
16) USEFUL CONTACTS	—
17) UL SPECIFICATION AND RATING	—

SAFETY REQUIREMENTS



ATTENTION:

Read the manual carefully before starting to use the control unit. Keep the instructions for future reference.



Do not open the device, touching any internal components can cause electric shock. Contact a voltage over 50 Volts can be fatal. To reduce the risk of electric shock, do not dismantle the back of the device for any reason. Moreover its opening would void the warranty.

Before connecting the device to the power supply, make sure that all the connections are correct. Always disconnect the unit from the supply before any cabling modification.



Any work on the equipment must be entrusted to a qualified engineer.

Failure to comply with these instructions can cause damages, fires or electric shock, and possible serious injuries!

POWER SUPPLY

The T1048 control unit can be supplied by 85 to 260 Vac-Vdc, irrespectively of polarity in Vdc. Before using it, make sure the power cable is not damaged, knotted or pinched. Do not tamper with the power cable. Never disconnect the unit by pulling the cable, avoid touching the pins. Do not carry out any connecting/disconnecting with wet hands. To disconnect the device, do not use objects such as levers. Immediately disconnect the device if you smell burning or see any smoke: contact technical service.

LIQUIDS

Do not expose the equipment to splashes or drops, do not position it in places with humidity exceeding 90% and never touch with wet or humid hands during storms. If any liquid penetrates the control unit, disconnect it immediately and contact technical service.

CLEANING

Disconnect the power cable before cleaning the control unit, use a dry cloth to dust it, without any solvent or detergents, and compressed air.

OBJECTS

Never insert any objects into the cracks of the control unit. If this happens, disconnect the control unit and contact an engineer.

USE RESERVED TO QUALIFIED PERSONNEL

The purchased goods are a sophisticated electronic device that is totally unsuitable to be used by non-qualified personnel. Any work must be carried out by a specialist engineer.

ACCESSORIES

The use of non-original accessories or spare parts can damage the unit and endanger users' safety. In the event of faults, contact technical service.

LOCATION

Install the control unit indoors, in a place protected from water splashes and sun rays. Do not place near heat sources exceeding the parameters stated in this manual. Position on a stable surface, far from any possible vibrations. Position the unit as far as possible from any intense magnetic fields.

REPAIRS

Do not open the control unit. For any fault, always use qualified personnel. The opening of the control unit and/or the removal of the series identifying label entails the automatic forfeiture of the warranty. The Warranty seal is applied to all devices, any attempt to open the unit would break the seal and cause the consequent automatic forfeiture of the warranty.

FUNCTION

To control the transformer correctly from a temperature point of view, enabling the VOTING function is allowed where the load distributed between the phases of the transformer is adequately balanced.

TECHNICAL INFORMATION

Mail: ufficiotecnico@tecsystem.it — tel: 02/4581861

ACCESSORIES

The following objects are present inside the box:

Control unit

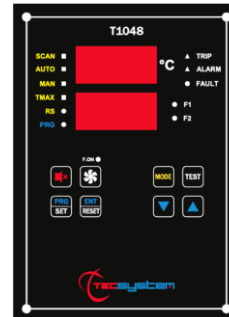

Start guide and QR code



4 Screws, Washers and Bolts nylon M5



1 supply terminal 3 poles pitch 5
Code: 2PL0367 - Screws tightening torque 0.5Nm



1 relay terminal 8 poles pitch 5
Code: 2PL0374 - Screws tightening torque 0.5Nm



2 relay terminal 2 poles pitch 7.62
Code: 2PL0451 - Screws tightening torque 0.5Nm



1 Pt100 sensor terminal 12 poles pitch 3.81
Code: 2PL0420 - Screws tightening torque 0.25Nm



1 Pt100 sensor terminal 3 poles pitch 3.81 (optional RS485)
Code: 2PL0366 - Screws tightening torque 0.25Nm



**ATTENTION: always install the device using the terminals included in the pack.
The use of terminals other than those included with the control unit might cause malfunctions.**

TECHNICAL SPECIFICATIONS

T1048 PT100

T1048 TCK

POWER SUPPLY

Supply rated values

85-260 Vac-Vdc
50/60HZ

85-260 Vac-Vdc
50/60HZ

Vdc with reversible polarities (protection fuse 2,5A 5x20 or 6.3x32)

•

•

INPUTS

4 sensors input (max section 1.5mm²)

Pt100
3wires

TCK

Connections on removable terminal strips

•

•

Input channels protected against electromagnetic interference

•

•

Cable compensation for thermistors

500m (1mm²)

100m compensating
cable

OUTPUTS

2 alarm relays (ALARM AND TRIP) SPDT

•

•

1 sensor or operating failure (FAULT) relay SPST

•

•

Output relays with 10A-250Vac-res COS Φ =1 contacts.

•

•

2 ventilation management relays SPST FAN1 AND FAN2: max 16A-250Vac-res COS Φ =1
(fuse 10A 6.3 x 32)

•

•

Ethernet output 10Base T / 100Base-TX Modbus TCP slave.

OPTIONAL

OPTIONAL

RS485 output modbus RTU

OPTIONAL

OPTIONAL

DIMENSIONS

232x166 mm – depth 60 mm

Hole 140 x 205 mm

Hole 140 x 205 mm

TESTS AND PERFORMANCE

Construction in compliance with CE regulations

•

•

Protection from electrical interference EN 61000-4-4

•

•

Dielectric strength 1500 Vac for a min. between output relays and sensors, relays and
power supply, power supply and sensors

•

•

Accuracy $\pm 1\%$ full scale value, ± 1 digit

•

•

Ambient operating temperature from -20°C to $+60^{\circ}\text{C}$

•

•

Humidity 90% non-condensing

•

•

Housing Polycarbonate

•

•

Polycarbonate frontal film IP65

•

•

Absorption 8VA

•

•

Data memory 10 years minimum

•

•

TECHNICAL SPECIFICATIONS

T1048 PT100

T1048 TCK

Digital linearity of sensor signal

•

•

Self-diagnostic circuit

•

•

Protection treatment of the electronic part

OPTIONAL

OPTIONAL

DISPLAY AND DATA MANAGEMENT

2 x 20,5mm displays with 3 digits to display temperatures, messages and channels

•

•

4 leds selection of display mode (SCAN-AUTO-MAN-T-MAX)

•

•

3 LEDs to display the state of the alarms of the selected channel (ALARM-TRIP-FAULT)

•

•

2 LEDs to display the state of FAN1 and FAN2

•

•

1 LED PRG/VIS status

•

•

Temperature reading range from -20°C to 220°C. Alarm settings 0°C to 220°C

•

•

1 alarm thresholds CH1-CH2-CH3

•

•

1 trip thresholds CH1-CH2-CH3

•

•

1 alarm threshold CH4

•

•

1 trip threshold CH4

•

•

2 ON-OFF thresholds for FAN 1 and FAN 2 in common for all enabled channels

•

•

Sensor diagnostics (Fcc-Foc-Fcd)

•

•

Data memory diagnostics (Ech)

•

•

Access to programming through front keyboard

•

•

Automatic exit from relay programming, display and test after 1 minute's inactivity

•

•

Incorrect programming warning

•

•

Selection between channel automatic scanning, hottest channel or manual scanning

•

•

Storage of maximum temperatures reached by channels and alarm status

•

•

Front key to reset the alarms

•

•

Audible alarm (ALARM) with silent key

•

•

Intellifan function

•

•

Voting function

•

•

Hysteresis function ALARM and TRIP (HYS)

•

•

Failsafe function

•

•

Key and Led enable forced ventilation F.ON

•

•

FRONT PANEL

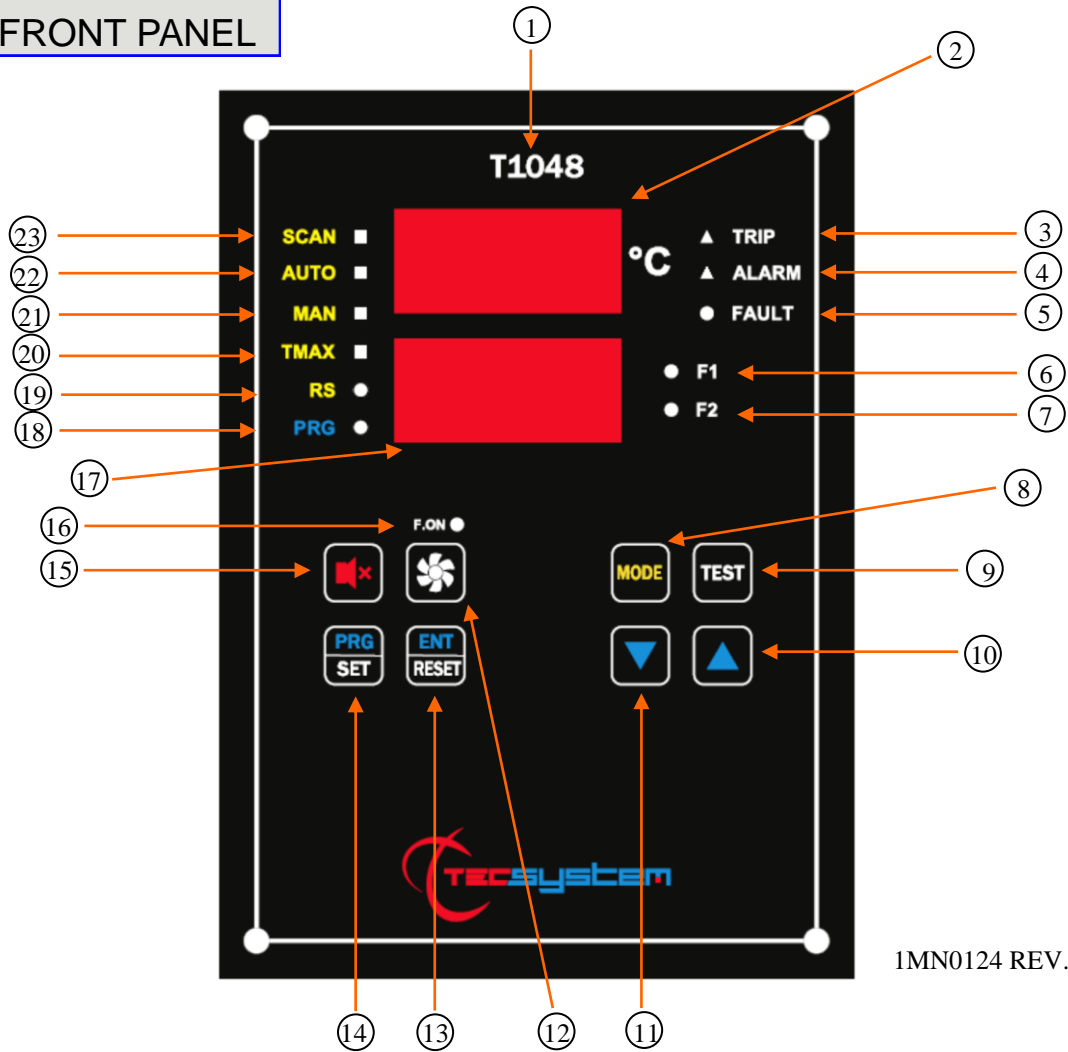

1MN0124 REV. 0

1)	Control unit series	13)	Enter/Reset button
2)	3-digit temperature display	14)	Programming / Setting key
3)	TRIP (red) LED	15)	Alarm silent key
4)	ALARM (yellow) LED	16)	F.ON (yellow) LED
5)	FAULT (red) LED	17)	3-digit channel display
6)	FAN 1 (yellow) LED	18)	PRG ON (yellow) LED
7)	FAN 2 (yellow) LED	19)	RS communication (green) LED
8)	Display mode selection key	20)	T-max mode selection (red) LED
9)	Led/relay test key	21)	Man mode selection (yellow) LED
10)	UP key	22)	Auto mode selection (green) LED
11)	DOWN key	23)	Scan mode selection (yellow) LED
12)	Key enable forced ventilation		

DISPLAY

The first display is dedicated to temperatures.

The second display to the monitored channel.

When the device is switched on or following a reset, the display shows: the control unit model, T1048, together with VER "00" (firmware version), option type sensor (PT100 or TCK), temperature range, communication option (RS485 or ETH) if available.

Pressing the MODE key, the display modes can be set:

- **SCAN:** the monitoring unit displays all the activated (°C) and deactivated (NO) channels scanning every 2 seconds.
- **AUTO:** the monitoring unit displays the hottest channel automatically.
- **MAN:** manual reading of the channel temperature using the up/down keys ▲▼
- **T.MAX:** the monitoring unit displays the highest temperature reached by the sensors and any situation of: alarm or fault occurred after the last reset. Select channels with up/down key ▲▼, reset values with RESET.

OPERATING PROGRAM CONTROL

To control the protection levels programmed, press the PRG key twice to access the **VIS** display mode. Repeatedly pressing the PRG key, you can scroll through all the previously loaded values in sequence.

After 1 minute's keyboard inactivity, the programming display procedure is automatically abandoned.

To stop the display, press the ENT key.

NOTES ON SCAN AND MAN FUNCTIONS

During the SCAN and MAN modes, the operation of the T1048 can be displayed.

1) RUN CPU:

This message appears when the unit operates regularly without any system error.

2) Ech Err:

This message appears when a damage in the EEPROM memory is detected.

Pressing Reset will cancel the message and restore the original default parameters, listed in the programming paragraph on pages 13-14. Return the control unit to TECSYSTEM for repairs.

3) CAL Err:

This message appears when damage is found in the measurement circuit.

The temperature values displayed might be incorrect. Return the control unit to TECSYSTEM for repairs.

4) Pt Err :

This message appears when it is detected that one or more PT100 sensors are not working correctly, FOC, FCC and FCD indications in the temperature sensor diagnostics paragraph on page 17. In case of **Err** the FAULT relay will be de-energised.

The above messages will be displayed following the 1-2-3-4 priority stated.

NOTE: regardless of the display mode, in case of a sensor fault (fcc, foc or fcd), the control unit will automatically switch to **SCAN (PRIVILEGED SCAN)** mode, immediately allowing you to see the fault on the relative channel **CH**. (**Mode** key is disabled).

LED TEST

We suggest carrying out the control unit LED test regularly.

For this operation, press the TEST key briefly; all the displays turn on for 2 seconds.

If one of the LEDS does not work, please return the control unit to TECSYSTEM for repair.

ALARM RELAY TEST

This function allows you to carry out a test of the relay operation without having to use further devices. To start the test procedure, keep the TEST button pressed for about 5 seconds: TST appears for 2 seconds, confirming you have entered the Relay Test mode.

The LED that is lit shows the relay to be tested; use the up/down key ▲▼ to select the desired relay.

Press the SET and RESET keys to energise and de-energise the relay to be tested; the display will show ON-OFF.

After 1 minute's keyboard inactivity, the RELAY TEST procedure will be automatically abandoned.

To stop the RELAY TEST procedure, press the TEST key.

ALARM RELAY SILENCING

If you want to silence the ALARM signal press the RESET key: the relay de-energises and the ALARM LED, which was fixed, will start flashing. Silencing is automatically disabled when the temperature goes below the ALARM threshold.

NOTE: you can stop the acoustic alarm by pressing the silent key . It works only for the acoustic signal, it doesn't change the alarm relay status.

MOUNTING

Drill a hole in the panel sheet with dimensions of 205mm x 140mm.

Drill four holes size Ø5.5mm distance 145mm X 212mm, see drawing below.

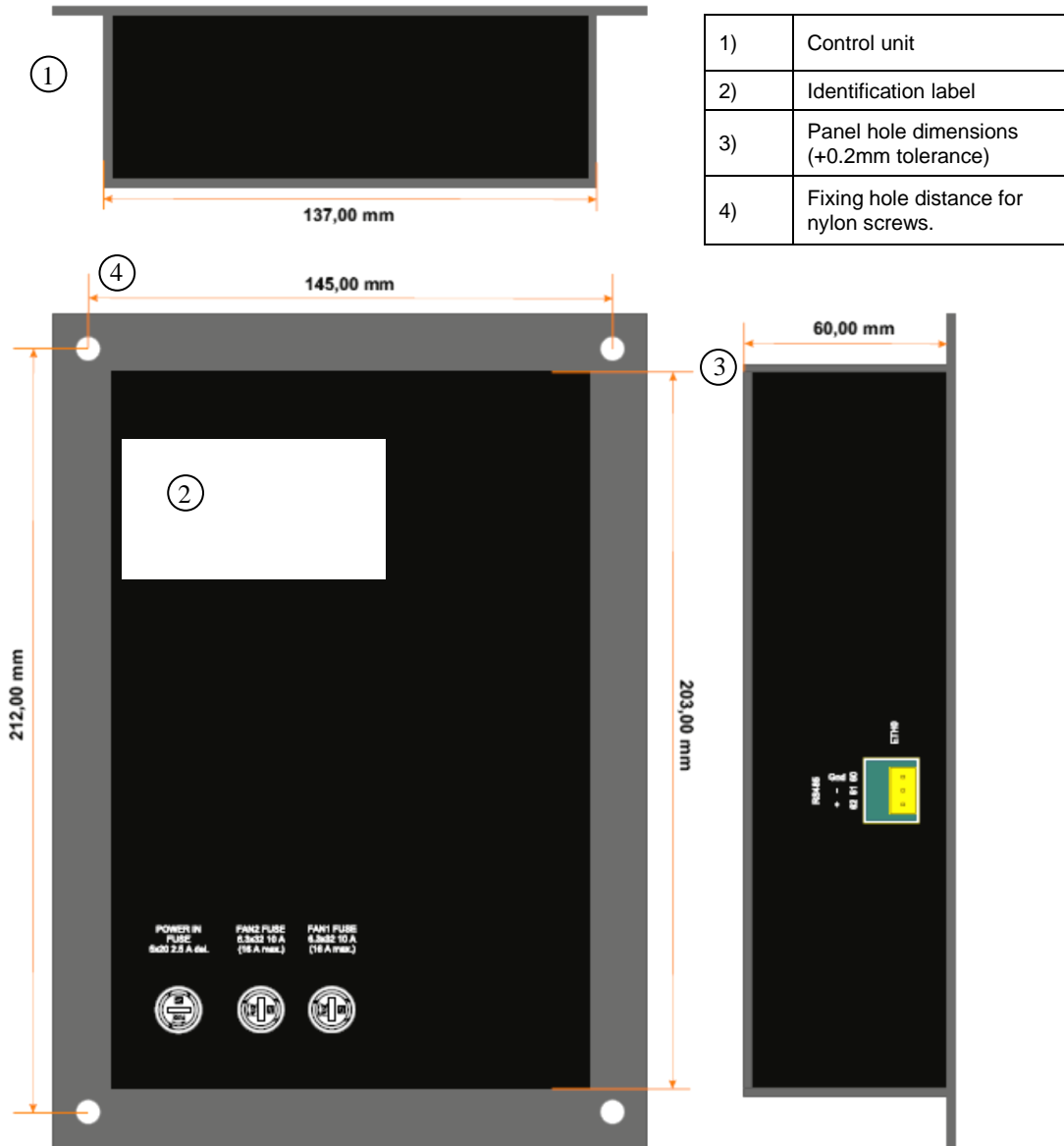

1MN0124 REV. 0

Firmly tighten the device with the 4 screws (nylon) supplied



5)	Screws, Washers and Bolts nylon M5	6)	Line-head screwdriver #1X100mm
----	------------------------------------	----	--------------------------------

ELECTRICAL CONNECTIONS

1MN0124 REV. 0

T1048

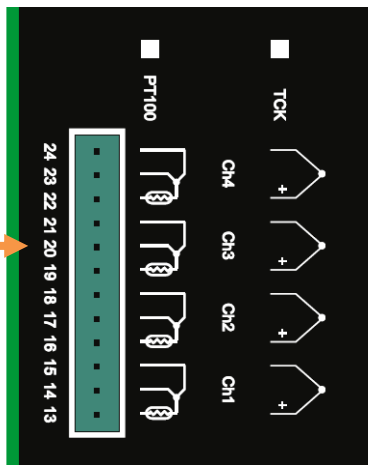
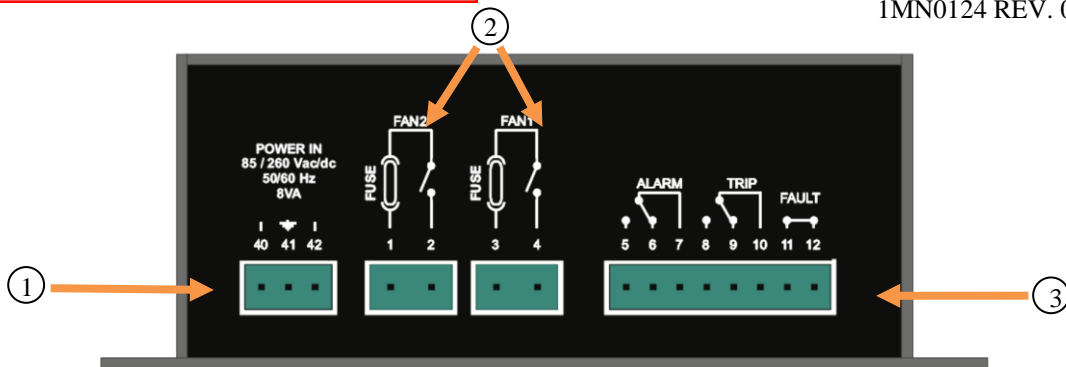

Pt100 CONNECTION EXAMPLE

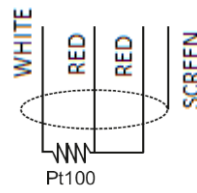

TCK CONNECTION EXAMPLE

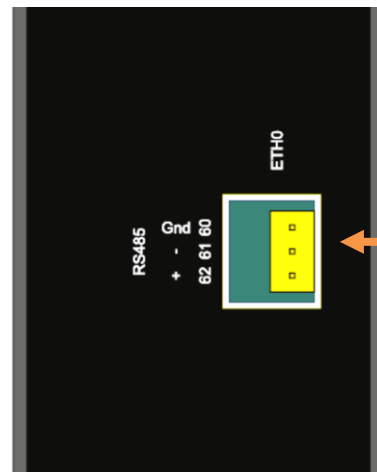
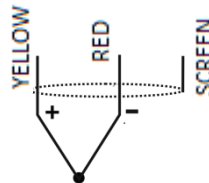

1)	Power supply 85-260Vac-dc 50/60Hz	4)	Pt100 or TCK sensors
2)	Relays (FAN2-FAN1)	5)	RS485 or ETHERNET output (Options on request)
3)	Relays (ALARM-TRIP-FAULT)	6)	Fuses – Power- Fan1 and Fan2



Note: before connecting the sensors to the control unit, read the measurement signal transfer paragraph on page 16

RELAY CONNECTION EXAMPLE

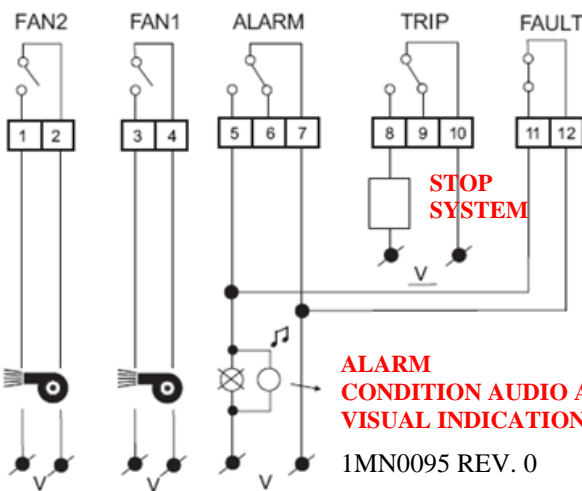

1MN0095 REV. 0

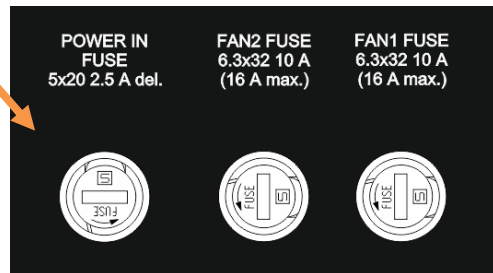

NOTE: POWER IN fuse for non-UL marked products, dimensions 6.3X32 2.5A.



Note: relay contact image in non-alarm condition, with the exception of the FAULT relay that opens: contact 11-12 open (NO) contacts 11-12 closed (NC) fault condition identification. Read the Alarms and Ventilation paragraph on page 12 and see the opening of the fault contact.

Output relay with 10A-250Vac-res COSΦ=1 contacts - FAN 1 and F2 16A-250Vac-res COSΦ=1 contacts.

POWER SUPPLY

The T1048 control unit has UNIVERSAL power supply, i.e. it can be supplied by 85 to 260 Vac-Vdc, 50/60 Hz irrespectively of polarity in Vdc (terminals 40-42).

This is obtained thanks to the use of a tested power supply unit, newly designed and manufactured, that frees installers from worrying about the correct Vac and Vdc supply.

The ground must always be connected to terminal 41.

When the unit is supplied directly by the secondary of the transformer to protect, it can be burnt out by strong overvoltages.

This happens if the main switch is closed and the transformer has no load (blank test).

The above-mentioned problems are much more evident when the 220 Vac voltage is taken directly from the transformer secondary bars and there is a fixed capacitor battery to phase the transformer itself.

To protect the control unit from line overvoltages, we suggest using the PT-73- 220 electronic discharger, designed by TECSYSTEM S.r.l. for this specific purpose. As an alternative we suggest using 110 Vac or, even better, 110 Vdc supply voltages.

If an existing control unit must be replaced with a new one, to guarantee its correct and safe operation, the sensor/relay/supply connecting terminals must be replaced with the new terminals supplied.

ALARMS AND VENTILATION

Carry out the electrical connections on the removable terminal blocks only after disconnecting them from the unit.

When the control unit is in one of the modes mentioned below, it does not monitor the temperature and the relays are all blocked.

- Vis. programming display
- PRG Programming
- Relay test

The ALARM and TRIP relays switch only when the set temperature thresholds are exceeded.

The FAULT contact opens (11-12) when the equipment is supplied, only if the unit detects no fault on switching on, and stays in this condition until one of the following events occurs:

- Data memory fault (Ech message).
- Pt100/TCK sensor fault (FCC short-circuited sensor, FOC interrupted sensor or Fcd quick temperature increase)
- CAL damage to the measurement circuit.
- Insufficient supply voltage.
- During the power on reset after programming (PRG), displaying the data (VIS) and test relay.

NOTE: do not connect the FAULT relay to the transformer tripping circuit to avoid unwanted system interruptions.

FAULT CONTACT

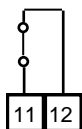

FAULT 11-12 NC: ALARM FAULT OR POWER OFF

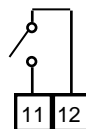

FAULT 11-12: NC POWER ON - NO FAULT

The FAN1 and FAN2 contacts can be used to control the cooling fans, or they can be inserted in the conditioning system of the transformer room, see paragraph cooling fan control on page 18.

NOTE: always disconnect the unit before performing any electrical connections.

FAULT AND RESET MESSAGE SEQUENCE









































Find below the sequence of fault messages and RESET function condition.

- | | | |
|-----------|----------------------------|--------------------------|
| 1) ECH | eeprom fault | erasable message |
| 2) CAL | measurement circuit fault | erasable message |
| 3) FCD | quick temp. increase fault | resettable condition |
| 4) ERR PT | FCC or FOC sensor fault | non-resettable condition |

PROGRAMMING

T1048

STEP	PRESS	EFFECT	PRESS	NOTES
1		Keep the PRG key pressed until the display shows PRG LED PRG will blink quickly		
2		Select SET (for Programming Manual) 1-2-3-4-5 table to call default programming.		Default SET/1 table: 1- 2-3-4-5 see at page 15.
3	 	Press PRG to continue programming manual (SET) Press ENT to confirm the programming of the selected table		
4		The ALARM CH1-CH2-CH3 threshold for is displayed Set the desired threshold, the Alarm LED flashes		Default 90°C
5		Set the desired threshold		
6		The TRIP CH1-CH2-CH3 threshold for is displayed Set the desired threshold, the Trip LED flashes		Default 119°C
7		Set the desired threshold		
8		The display shows FAN 1 (CH 1-2-3) led Fan1 flashes.		Default YES
9		Select YES / NO / INT		If you select INT read notes page 18 function.
10		Enabling CH4		Default CH4 YES
11		Select YES or NO		To enable YES NO to disable CH4
12		The ALARM CH 4 threshold for is displayed. Set the desired threshold, the Alarm LED flashes		If CH4 not enabled jumps to step 16
13		Set the desired threshold		Default 120°C
14		The TRIP CH4 threshold for is displayed Set the desired threshold, the Trip LED flashes		
15		Set the desired threshold		Default 140°C
16		The display shows FAN 2 (CH4)		Default YES
17		Select YES or NO		YES to enable FAN2 No to disable
18		The display shows ON (CH1-2-3) FAN1 flashes		Default 70°C
19		Set the desired threshold FOR FAN1 ON		If you select FAN1 NO skip to step 24. Selected INT flashing LEDs FAN1 and FAN2
20		The display shows OFF (CH1-2-3) flashes FAN1		Default 60°C

21		Set the desired threshold	 	
22		The display shows ON (CH4) FAN2 flashes		Default 45°C
23		Set the desired threshold	 	
24		The display shows OFF (CH4) FAN2 flashes		Default 35°C
25		Set the desired threshold	 	
26		HFN (NO) is displayed The FAN1-FAN2 LEDs flash		Fan cyclic test for 5 min. every "n" hours
27		Set the desired number of hours	 	Default NO = function disabled
28		FCD (NO) is displayed		Fault for quick temperature increase (°C/sec)
29		Set the desired value (FCD info on page 32)	 	Default NO (function excluded)
30		VOT (NO) is displayed (VOTING info on page 17)		To enable YES NO to disable VOTING
31		Select YES or NO	 	Default NO (function excluded)
32		The display shows FLS (ALARM) Blinking LED ALARM		Info FAIL SAFE on page 31. Read carefully before modify the parameter
33		Select YES or NO	 	Default NO
34		The display shows FLS (TRIP) Blinking LED TRIP		Read carefully before modify the parameter
35		Select YES or NO	 	Default NO
36		The display shows HYS ALARM		See paragraph hysteresis page 17
37		Select YES or NO	 	Default NO
38		The display shows HYS TRIP		See paragraph hysteresis page 17
39		Select YES or NO	 	Default NO
		Steps 40-45 only for RS485 version BASIC and ETH jumps to step 46		
40		ADR <> "datum" is displayed		Modbus address Default 001
41		Set the address	 	From 1 to 255
42		BDR <> "datum" is displayed		Modbus transmission speed Default 19.2 Kb/s
43		Set the desired speed	 	From 2.4 Kb/s to 38.4 Kb/s
44		PAR <> "datum" is displayed		Parity bit selection Default EVE
45		Set the desired parity bit	 	None (No), Even (EVE), Odd (ODD)
46		END is displayed Press ENT to save the set data and exit programming		End of programming Err: incorrect programming of the LED values (note 6)
47		PRG to return to step 1		

DEFAULT PROGRAMMING TABLES

The tables programming: SET-1-2-3-4-5 allow a fast and optimal programming, basic, of the device. They are simplified and useful support iteration man - machine.

The table in SET shows the default parameters for-set. By accessing to the SET programming the value can be changed manually, the other tables (1-2-3-4-5) are not editable. To access the table in SET see the programming step 3 at page 13.

PARAMETERS	Table SET/1	Table 2	Table 3	Table 4	Table 5
ALARM CH1-CH2-CH3	90°C	110°C	120°C	130°C	130°C
TRIP CH1-CH2-CH3	119°C	130°C	140°C	145°C	145°C
FAN 1 CH1-CH2-CH3	YES	YES	INT	INT	YES
CH4	YES	YES	YES	YES	YES
ALARM CH4	120°C	45°C	145°C	145°C	125°C
TRIP CH4	140°C	50°C	150°C	150°C	140°C
FAN 2 CH4	YES	YES	INT	INT	YES
FAN 1 ON	70°C	70°C	90°C	90°C	90°C
FAN 1 OFF	60°C	60°C	80°C	80°C	80°C
FAN 2 ON	45°C	40°C	90°C	90°C	40°C
FAN 2 OFF	35°C	30°C	80°C	80°C	30°C
HFN	NO	NO	NO	NO	NO
FCD	NO	NO	NO	NO	NO
VOTING	NO	NO	NO	NO	NO
FAIL SAFE ALARM	NO	NO	NO	NO	NO
FAIL SAFE TRIP	NO	NO	NO	NO	NO
HYS ALARM	NO	NO	NO	NO	NO
HYS TRIP	NO	NO	NO	NO	NO

The communication parameters for Modbus RS485: ADR-BDR-PAR are not included in the predefined tables they can be edited independently selecting the SET table and modify it manually.

Note: the user is obliged to check the parameters and select the appropriate table to its application. The first time you turn on the unit the table is SET 1, then it will keep the selected parameters stored by the user.

PROGRAMMING NOTES

- 1) The MODE key allows reversing the programming steps according to the sequence 1-10-28-30-47
- 2) The TEST key allows exiting programming without saving the modified data.
- 3) After 1 minute's keyboard inactivity programming is abandoned without saving the data.
- 4) During programming the control unit does not control/protect the monitored machine.
- 5) At the end of programming the control unit is restarted and the FAULT relay is disabled until the unit is fully restarted.
- 6) If pressing ENT, "Err" appears, it means that one of the following mistakes has been made:

ERR ALL. = ALARM \geq TRIP (CH1-CH2-CH3 or CH4)
 ERR FAN = FAN-OFF \geq FAN-ON. (FAN1 OR FAN2)

Press PRG to return to step 1 and correct the data.

NOTE: EVERY TIME THE CONTROL UNIT IS PROGRAMMED WITH DATA SAVING CONFIRMATION, THE VALUES STORED IN T-MAX ARE RESET TO THE TIME OF SAVING.



ATTENTION:

We recommend you check the unit's programming before starting the device.

The default parameters set by TECSYSTEM might not match your requirements.

Programming the device is the end user's responsibility, the settings of the alarm thresholds and the enabling of the functions described in this manual must be checked (by a specialized engineer) according to the application and features of the system the control unit is installed on.

TEMPERATURE SENSORS

Each Pt100 temperature sensor has a white wire and two red (CEI 75.8), each temperature sensor TCK has one conductor yellow and one red, in the picture on page 11 shows the disposition in the terminal board of the connection cables to the control unit.

CH2 must always be referred to transformer central column.

Channel CH4 must be referred either to the transformer core or to Pt100 sensor for room, if you want to control the temperature of transformer room taking advantage of the T1048 control unit.

TCK NOTE: For a correct temperature measurement is necessary that the cold junction of the probe is stabilized at room temperature, in the control unit operating range $-20^{\circ}\text{C} + 60^{\circ}\text{C}$.

MEASUREMENT SIGNAL TRANSFER

All the cables transferring the sensors measurement signals must comply with the following under all circumstances:

1. Every Pt100 must be connected with a three-wire cable having a minimum section of 0.35mm^2 and a maximum of 1mm^2 .
2. Every TCK must be connected with a 2-wire cable compensated: Chromium - aluminum (yellow-red), joints or terminal support must also be compensated.
3. The extension cable must be screened with tinned copper braid with an 80% cover
4. Conductors must be twisted, maximum recommended step 60mm
5. The cable screening must be grounded only with a termination, preferably on the unit side.
6. The sensors' signal transfer cable must not be near electrical cables, either low or medium-high voltage.
7. The sensors cable and the signal transfer cable must be laid in a straight line, without any winding.
8. Any caps used to butt conductors must be crimped properly to avoid false contacts.

NOTE: to install the sensors and signal transferring cable correctly, read the sensor and SCS installation note manual.

What may happen when installation rules are not complied with.

1) The electrical field propagating from the power line of another circuit, couples capacitively with the conductors (in particular with unshielded cables). The effect of this coupling creates a signal that overlaps the signal transmitted by the nearby conductors, causing incorrect readings.

2) The variations in magnetic flux in the power lines may induce an electromotive force on the signal transferring cables (in particular non-twisted cables), that, being a closed circuit, generates a current. This interference current, multiplied by the circuit resistance, gives a voltage value that overlaps the signal to be transmitted, distorting the sensor measurement.

3) False contacts can alter the signal with the consequent variation in the temperature detected.

In specific cases, when the rules for connecting the Pt100 sensors are not complied with, the following anomalies can occur between the SCS box and the temperature control unit:

- a) incorrect temperature readings, alarms or anomalous tripping
- b) mechanical / electrical fault of the Pt100 sensors
- c) damage to the Pt100 inputs of the control unit.

For the Pt100 sensor connection TECSYSTEM S.r.l. has designed its own special cable to transfer the measurement signals, CEI-compliant, with all the protection requirements provided for: model CT-ES

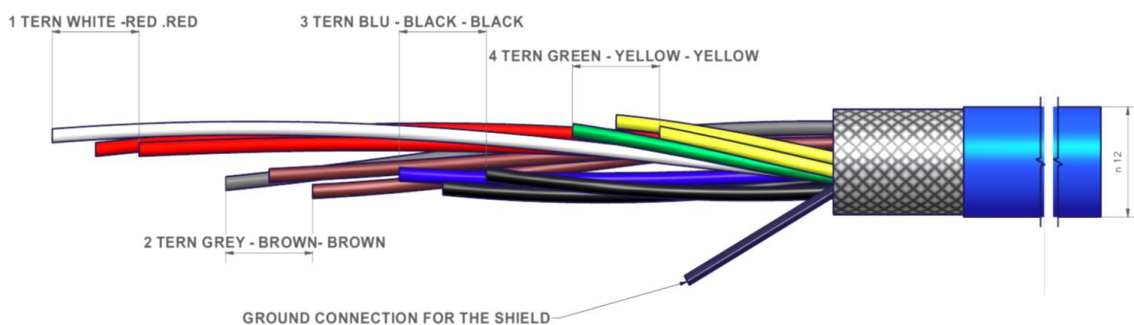

NOTE: the use of cables not complying with the above might cause reading anomalies. It is always important to take into account that any interference on the signal lines might cause anomalies on the Pt100 inputs (CH1-CH2-CH3-CH4.) or on the sensors themselves.

All "T" series control units have linearity of the sensor signal, with a maximum error of 1% of full scale value.

TEMPERATURE SENSOR DIAGNOSTICS

In case of failure or exceeded full scale value of one of the thermometric sensors installed on the machine to protect, the FAULT relay opens immediately with the relative warning of faulty sensor on the corresponding channel.

Fcc indicates sensor short-circuited (Pt100) or minimum full scale value of the control unit exceeded -23°C

Foc indicates sensor interrupted (Pt100) or maximum full scale value of the control unit exceeded 228°C

To eliminate the message and reset the opening of the Fault contact, it is necessary to check the sensors connections and replace the faulty sensor (if any). If the minimum/maximum full scale value has been reached, check that the ambient conditions match the control unit reading.

Note: exceeding the minimum/maximum full scale value can also be caused by interference on the sensor lines; in this case we recommend that you check:

The correct installation of the sensors and above all of the extension cable (as stated in the paragraph MEASUREMENT SIGNAL TRANSFER)

The activation of: VOTING (see below) or FCD (see page 32) according to the conditions of the system.

CAL message display: it appears when damage is found in the measurement circuit. The temperature values displayed might be incorrect. Return the control unit to TECSYSTEM for repairs.

VOTING FUNCTION

The voting function derives from the redundancy concept that consists in duplicating the components of a system to increase their **reliability**.

How does VOTING work?

Using the redundancy principle, we use the sensors installed on the three phases U-V-W to monitor the transformer's operation, and at the same time ascertain the sensors are working correctly, discriminating against any false alarms (generated by installation errors).

By activating the **VOTING "YES"** function, the control unit compares the temperature values recorded on the monitored CH1-CH2-CH3 channels and enables the switching of the **TRIP** contact only if the **TRIP** threshold has been exceeded on at least two channels over the same period T.

By selecting **VOTING "NO"** the function will be disabled.

Note: by setting Voting "Yes" the switching of the **ALARM** contact will anyway indicate the alarm threshold on each individual channel has been exceeded.

To enable the Voting function, read the programming section on pages 13-14.



Attention: To control the transformer correctly from a temperature point of view, enabling the VOTING function is allowed where the load distributed between the phases of the transformer is adequately balanced. In addition, any conditions of FAULT: FCC-FCC-FCD on two or more channels, with active voting, can determine the TRIP contact inhibition.

TEMPERATURE DIAGNOSTICS

When one of the temperature sensors senses a temperature 1°C higher than the alarm threshold, 5 seconds later the **ALARM** relay switches and the *ALARM* LED of the affected channel (CH*n*) lights up.

When the trip temperature limit is exceeded, the **TRIP** relay switches and the *TRIP* LED of the affected channel (CH*n*) lights up.

As soon as the recorded temperature returns to values equal to or lower than the limit set for the **ALARM** and **TRIP** relays switching, these relays de-energise and the corresponding LEDs switch off.

The **ALARM** and **TRIP** values are kept in the internal memory: they can be recalled by entering the Vis modes (programmed parameter display) and modified in PRG (programming) mode.

HYSTERESIS FUNCTION HYS (RELAY ALARM AND TRIP)

Activating the function **HYS ALARM "YES"**, the control unit switches the relay ALARM just found a temperature higher than 1 ° C, compared to set value as alarm limit, keeps the relay energized until the temperature has dropped to 5 ° C under the threshold alarm.

Activating the function **HYD TRIP "YES"** the controller switches the relay TRIP just found a temperature higher than 1 ° C, compared to set value as trip limit, keeps the relay energized until the temperature has dropped to 5 ° C under threshold trip.

Selecting **HYS "NO"** the activation of ALARM relay or TRIP will behave as described in paragraph TEMPERATURE SENSOR DIAGNOSTICS see at page 17.

PROGRAMMED DATA DIAGNOSTICS

In case of failure of the internal memory or corruption of programmed data, just after switching on, **Ech** appears with the relevant Fault contact.

In this case, for safety reasons, the default parameters are loaded automatically (see programming table on pages 13-14). Eliminate **Ech** by pressing RESET and run programming to enter the desired values.

Finally switch the unit off and back on to check the memory works correctly, if it is damaged **Ech** will be displayed again (send the control unit to TECSYSTEM srl for repairs).

COOLING FAN CONTROL

The T1048 control unit is fitted with two FAN controls (FAN1 and FAN2) and, if programmed correctly, can control the fans switching ON and OFF to cool the transformer.

The FAN1 and FAN2 contacts can manage cooling the transformer and the room where it is installed.

By connecting FAN1 to the tangential cooling system (the two bars on the transformer) and FAN2 to the extractor, you will improve the air flow in the cabin; moreover, the cabin temperature will no longer need to be managed by a thermostat outside the system.

The fans can be controlled in two different ways:

- Using the temperatures sensed by the sensors on the three columns (FAN1)
CHF 1.2.3 (ex. ON at 70°C - OFF at 60°C)
- Using the extra sensor (**CH4/YES**) dedicated to the ambient temperature inside the transformer room (FAN2).
CHF 4 (ex. ON at 45°C - OFF at 35°C)

The ON and OFF values are programmable according to the device range from 1°C to 220°C.



The key enabling forced ventilation allows you to: manually start the outputs of active fans (FAN1 eFAN2). The manual activation is indicated of the light on of the led F.ON.

The FAN 1 / FAN 2 LED lights up when the temperature exceeds 1°C the FAN ON threshold, the corresponding relay switches, and turns off when the temperature goes below 1°C the FAN OFF threshold, the corresponding relay switches.

FAN TEST

By programming (**HF_n**), it is possible to have the fans operating 5 minutes every "xxx" hours, regardless of the column or ambient temperature values (i.e.: with HF_n=001 the fans are activated for 5 minutes every hour).

This function aims at verifying the fan operation and their control apparatus periodically.

By setting **NO** this function is inhibited.

To enable the HF_n function, read the programming section on pages 13-14.

INTELLIFAN FUNCTION

What it is used for:

The Intellifan function allows reducing the transformer's thermal shock by partially anticipating (one bar at the time) the activation of the tangential ventilation system.

The reduction in the transformer's thermal shock will extend the life of the transformer and of the ventilation system itself.

By enabling the **FAN1 "INT"** function, the control unit will alternate the activation (each 30 minutes) of the FAN1 and FAN2 contacts, anticipating the activation of the ventilation system at the intermediate value included between FAN1 ON and FAN1 OFF.

EX. FAN1 ON = 70°C and FAN1 OFF = 60°C **FAN INT. ACTIVATION = 65°C**

Before enabling the function, check that the connection of the two ventilation bars is distributed in such a way that the RH bar is connected to the FAN2 relay, pins 1-2, and the LH bar is connected to FAN1, pins 3-4.

By selecting **FAN1 "NO or YES"**, the function will be disabled.

Note: once the FAN1 threshold is exceeded, the control unit will activate both bars.

To enable the **INTELLIFAN** function, read the programming section on pages 13-14.

Note: for correctly working of the INTELLIFAN function we recommend you observe ΔT 10°C between FAN1 ON and FAN1 OFF. The connection to the VRT series devices, where Intellifan is enabled, must be made between the contacts FAN1 - COM-EN1 and FAN2 - COM-EN2.



IMPORTANT WARNING

Before carrying out the isolation test of the electrical panel the control unit is installed on, disconnect it together with the sensors from the power supply to prevent it from being seriously damaged.

OPTIONAL OUTPUT

INTRODUCTION TO THE MODBUS INSIDE MODULE (ONLY RS485 VERSION)

The MODBUS INSIDE expansion module is built in the monitoring unit and allows data transfer on a RS485 network with MODBUS RTU protocol.

OPERATING NOTES

For the module to work correctly, it is necessary to set the RS485 network set-up parameters: address, baud rate, parity bit.

See programming steps 40 to 45 on page 14.

The serial communication of the temperature control monitoring unit is active only when the T1048 is in temperature control mode in one of the intended modes (Scan, Auto, Man and T.Max).

When other functions such as programming, programming display and relay test are activated, the ModBus communication is temporarily deactivated.

DATA TRANSMISSION ON MODBUS NETWORK

The MODBUS INSIDE internal module allows connecting the T1048 control unit to an RS485 network with Modbus RTU protocol in order to read the data shown in the MODBUS table on page 22 and write those in the notes for remote programming; the module is always in slave mode.

The T1048 control unit is in communication with the network only when it is in temperature reading mode, while it is inactive when in the following modes: display, programming and relay test.

RS485 ELECTRICAL CONNECTIONS

As far as the signal cable to be used in order to ensure the correct network operation is concerned, we recommend you follow the provisions of the EIA RS485 standard which suggests using a 24AWG twisted pair.

The twisted pair that connects units in RS485 might need a 120 ohm end resistor on the last unit of the series.

Connect the twisted pair paying attention to polarities and lay the network avoiding to make sharp bends or ring windings in order not to modify line impedance. If necessary, the GND terminal for grounding is also available.

Always position the RS485 twisted pair far from power cables.

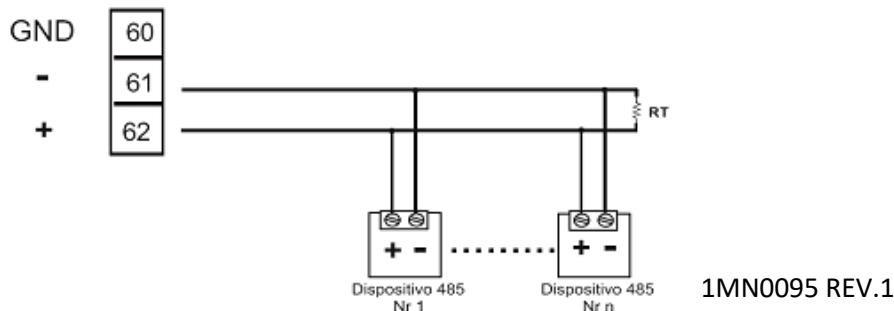

DATA FRAME

The frame in asynchronous transmission consists of: 1 start bit, 8 data bits, 1 parity bit (even or odd, if the parity has been set) and 1 stop bit. Note: with selection NO parity (none) set 2 stop bits.

Admitted baud rates are: 2400, 4800, 9600, 19200 and 38400.

If not otherwise specified, the word length (DATA) is 16 bits.

INTRODUCTION TO THE ETHERNET MODULE (ONLY ETH VERSION)

The Ethernet connectivity of the T1048 allows you to implement the functions of the Tecsystem control units directly into your monitoring system.

The integrated module includes all the essential network features, among which a 10Base T / 100Base-TX Ethernet connection, TCP / IP full stack suitable to work as Modbus TCP slave.

The unit can be used for remote configuration, monitoring in real time or problem solving.

The Windows-based Telnet system allows configuring the T1048 easily into a sub-network with specific IP addresses.

DATA TRANSMISSION

The Ethernet module allows you to connect to the control unit through Modbus TCP slave so that you can: read the data on the Modbus table on page 22 and write those in the paragraph regarding the remote programming notes.

The ETH module is always in slave mode.

The T1048 control unit is in communication with the network only when it is in temperature reading mode, while it is inactive when in the following modes: display, programming and relay test.

OPERATING NOTES

The communication of the temperature control monitoring unit is active only when the T1048 is in temperature control mode (Scan, Auto, Man and T.Max).
When other functions such as programming, programming display and relay test are activated, the ModBus communication is temporarily deactivated.

NOTES ON ETHERNET ELECTRICAL CONNECTIONS

As to the signal cable to use in order to guarantee correct operation, it is necessary to use a CAT 7 Ethernet cable with RJ45 connector with the following specifications:

- 4 twisted pairs 23AWG
- Tinned copper braid with an 80% cover.
- Always position the Ethernet cable far away from power cables.

FUNCTION CODE

The ModBus module supports the following function codes:

- 3₍₁₀₎**: - holding register reading
16₍₁₀₎: - register multiple writing

If ModBus receives a message and a CRC error is detected, no answer is given.

CODE 3₍₁₀₎.

Request:

Slave address, code 3₍₁₀₎, Starting address HI, Starting address LO, Number of Point HI, Number of Point LO, Crc LO, Crc HI.

Answer:

Slave address, code 3₍₁₀₎, Byte count, Data HI, Data LO....., Crc LO, Crc HI.

CODE 16₍₁₀₎.

Request:

Slave address, code 16₍₁₀₎, Starting address HI, Starting address LO, Number of Point HI, Number of Point LO, Byte count, Data HI, Data LO....., Crc LO, Crc HI.

Answer:

Slave address, code 16₍₁₀₎, Starting address HI, Starting address LO, Number of Register HI, Number of register LO, Crc LO, Crc HI.

NOTES FOR REMOTE PROGRAMMING

The writable registers are shown in TABLE MODBUS MAPPING referred to as W or RW (**write or read / write**). max number of registers 72, see table page. 22.

In the case in which the channel is not enabled and / or the information is not provided we have the following answers:

1. Temperatures measured = 0000 (0 ° C)
2. Temperatures AL. / TRP = value written in E2PROM
3. Channel status = 0000
4. Setting channel = % 00000000, xxxxxx0% (x = na)

If WRITE data must always respect the rule T_trip > T_alarm and FAN_ON > FAN_OFF.

Hysteresis ALARM / TRIP: 0 = no hysteresis; 1 = YES Hysteresis (5 ° C).

This function must be interpreted as: - Hysteresis = NO → Alarm / Trip become active if T > threshold, are disabled if T ≤ threshold; - Hysteresis = YES → Alarm / Trip become active if T > threshold, are disabled if T ≤ (threshold-5 ° C);

In case you try to set these thresholds incorrectly, the control unit T1048 will not proceed with the programming and storage of data, therefore in subsequent readings will read the data from the previous schedule.

After having sent a request for writing the control unit will take a time of about 1 " to store the data in eeprom, during the step of storing the module ModBus will not be able to process additional requests.

If the demand for programming is successful, the unit automatically resets and loads the new settings.

In the event that information is sent in writing to a register can't be written (only READ) data will be trashed without affecting the received message.

The information "RELAY STATUS" indicates the state of excitation of the coils of the relays, so it will be subject to the commands of "FAIL SAFE".

In the case of writing data "CPU SETTING" with bits "Failsafe Fault" = 0, it will be forced = 1 so as not to affect the validity of the data packet.

From the point of view of the control unit Modbus connection is considered as a normal T1048.

At the end of the write command (Write) is carried out a check of compatibility data:

- If you have a non-compatibility "exception" for an answer and the data packet is rejected in its entirety. The code of the first erroneous data can be obtained by reading the log "Error received data" (Note: this code is lost during RESET or new power or writing data in E2PROM).

- if the data are correct, they are transferred to the non-volatile memory (E2PROM), resets the historical data (Tmax = 0 ° C) and is subsequently forced a reset of the system
- If the WRITE command implies only writing "COMMANDS" it will be implemented autonomously and without RESET, ie without affecting the data of the control unit.

To avoid a long time both in reception that transmission is placed a limit of data equal to "80 Registers"

ERROR CODES (exception codes)

In case of a wrong request, ModBus will answer with modified codes and codified errors according to the following:

- 1: - Unsupported function code
- 2: - Wrong data address
- 3: - Wrong data (for instance length)

The memory area containing the HFN datum must undergo no forcing.

In the case in which all the fans are turned off (FAN1, FAN2 and INT) the test of the relay will not take place.

ILLEGAL DATA

On the other hand, some combinations are programming errors because they are wrong settings; in this case the error code is ILLEGAL_DATA This information is accessible to ModBus reading the register 7, see at page 22.

NO ERROR	No error 00
CH_1 Trip ≤ Alarm	Code error 01
CH_2 Trip ≤ Alarm	Code error 02
CH_3 Trip ≤ Alarm	Code error 03
CH_4 Trip ≤ Alarm	Code error 04
FAN_1 ON ≤ OFF	Code error 017
FAN_2 ON ≤ OFF	Code error 018
No channels enabled	Code error 019
Value HFN > max see table: SYSTEM - Setting and Status	Code error 020
Value FCD > max see table: SYSTEM - Setting and Status	Code error 021
Value 4.20 > max see table: SYSTEM - Setting and Status	Code error 022
Value Voting > max see table: SYSTEM - Setting and Status	Code error 023
Voting wrong function (channels not enabled)	Code error 024

Note. If the value of Voting is higher than the max value expected for the model in question, it will be set equal to "0", that is NO_VOTING.

GENERAL UNIT NOTE

The models of the unit can be equipped with different options; to avoid disruption of production, their existence is defined by Fw indicated power, with messages dedicated on display LEDs.

This information can be accessed by reading the Modbus register 6 (option) with the following meaning:

LOW Byte

- Bit_1 : option Ethernet
- Bit_2/3 : type sensors 11=PT100; 00=TCK
- Bit_4 : option RS485

HIGH Byter

- Bit_1/1 = 01 - Range -20°C + 220°C

Ethernet functions has disabled ModBus and 4.20 mA from panel will be readable from the center

Note: in case the values programmed from ModBus are out of range, it will generate a "exception" error response to date.

FREQUENCY OF QUESTION (Polling).

It is advisable to adopt polling frequencies greater than or equal to 1 second.

Questions frequently can overload the system, without bringing any benefit. In multi-device RS485 lines, interrogated in sequence, it may be useful to enter a delay between polls in relation to: the number of connected devices, the communication speed and the number of read registers.

MODBUS MAPPING TABLE

HEADER (information and commands):

Address LO (10)	Data HI	Data LO	R: read W:write RW: read/write
1	Modello – MSD (ASCII)	Modello - 3° Digit (ASCII)	R
2	Modello - 2° Digit (ASCII)	Modello – LSD (ASCII)	R
3	Space (20H)	Vers. Fw – MSD(ASCII)	R
4	Vers. Fw - 2° Digit (ASCII)	Vers. Fw – LSD(ASCII)	R
5	Channels qty (2*ASCII)		R
6	Options (see note)	Options (see note)	R
7	00	Wrong datum received	R-see tab.
8	00	Info various causes	R-see tab
9	00	Commands	W-see tab.

SYSTEM: Setting and Status

Address LO (10)	Data HI	Data LO	Note 1	Note 2	R: read W:write RW: read/write
10	00	HFN (Fan test)	0=No test	1÷200h	RW
11	00	FCD	temperature increment	0=No FCD 1÷30°/sec	RW
12	00	Voting	0=No Voting 1=YES		RW
13	00	CPU Setting	See Note		RW
14	00	CPU Error	See Note		R
15	00	Relays Status	See Note		R
16	00	FREE	See Note		
17	00	Address	Modbus address	1÷255	R
18	00	Bdr	Modbus baud rate	0=2400 1=4800 2=9600 3=19200 4=38400	R
19	00	Parity	Modbus parity bit	0=No 1=Even 2=Odd	R
20	00	FREE	See Note		R

TEMPERATURE FANS:

Address LO ₍₁₀₎	Data HI	Data LO	Note 1	Note 2	R: read W:write RW: read/write
21	2'compl. sign	Fan_1 ON	1° to÷ 220°		RW
22	2'compl. sign	Fan_1 OFF	1° to÷ 220°		RW
23	2'compl. sign	Fan_2 ON	1° to÷ 220°		RW
24	2'compl. sign	Fan_2 OFF	1° to÷ 220°		RW

TEMPERATURES channels 1÷4:

Address LO ₍₁₀₎	Data HI	Data LO	Note 1	Note 2	R: read W:write RW: read/write
25	2'compl. sign	2'compl. Ch1 temper.	-23° ÷ 228°		R
26	2'compl. sign	2'compl. Ch1 max temperat.	1° ÷ 220°		R
27	2'compl. sign	2'compl. Ch1 temper. alarm set point	1° ÷ 220°	(AL)	RW
28	2'compl. sign	2'compl. Ch1 temper. trip set point	1° ÷ 220°	(TRP)	RW
29	2'compl. sign	2'compl. Ch2 temper.	-23° ÷ 228°		R
30	2'compl. sign	2'compl. Ch2 max temperat.	1° ÷ 220°		R
31	2'compl. sign	2'compl. Ch2 temper. alarm set point	1° ÷ 220°	As (AL)	R
32	2'compl. sign	2'compl. Ch2 temper. trip set point	1° ÷ 220°	As (TRP)	R
33	2'compl. sign	2'compl. Ch3 temper.	-23° ÷ 228°		R
34	2'compl. sign	2'compl. Ch3 max temperat.	1° ÷ 220°		R
35	2'compl. sign	2'compl. Ch3 temper. alarm set point	1° ÷ 220°	As (AL)	R
36	2'compl. sign	2'compl. Ch3 temper. trip set point	1° ÷ 220°	As (TRP)	R
37	2'compl. sign	2'compl. Ch4 temper.	-23° ÷ 228°		R
38	2'compl. sign	2'compl. Ch4 max temperat.	1° ÷ 220°		R
39	2'compl. sign	2'compl. Ch4 temper. alarm set point	1° ÷ 220°	As (AL)	RW
40	2'compl. sign	2'compl. Ch4 temper. trip set point	1° ÷ 220°	As (TRP)	RW

Address LO ⁽¹⁰⁾	Data HI	Data LO	Note 1	Note 2	R: read W:write RW: read/write
41	00	00	00		R
42	00	00	00		R
43	00	00	00		R
44	00	00	00		R
45	00	00	00		R
46	00	00	00		R
47	00	00	00		R
48	00	00	00		R
41	00	00	00		R
49	00	00	00		R
50	00	00	00		R
51	00	00	00		R
52	00	00	00		R
53	00	00	00		R
54	00	00	00		R
55	00	00	00		R
56	00	00	00		R

CHANNELs 1-4: Setting

Address LO (10)	Data HI	Data LO	Note 1	Note 2	R: read W:write RW: read/write
57	00	Ch1 Setting	See Note CHx		RW
58	00	Ch2 Setting	See Note CHx		RW
59	00	Ch3 Setting	See Note CHx		RW
60	00	Ch4 Setting	See Note CHx		RW
61	00	00	00		R
62	00	00	00		R
63	00	00	00		R
64	00	00	00		R

CHANNELs 1-4: Status

Address LO (10)	Data HI	Data LO	Note 1	Note 2	R: read W:write RW: read/write
65	Ch1 story	Ch1 status	See Note CHx		R
66	Ch2 story	Ch2 status	See Note CHx		R
67	Ch3 story	Ch3 status	See Note CHx		R
68	Ch4 story	Ch4 status	See Note CHx		R
69	00	00	00		R
70	00	00	00		R
71	00	00	00		R
72	00	00	00		R

INFO various causes (READ)

BIT 7	BIT 6	BIT 5	BIT 4	BIT 3	BIT 2	BIT 1	BIT 0
--	--	--	-	-	-	Status manual fan	(*) RESET (R) has taken place

COMMANDS (WRITE)

BIT 7	BIT 6	BIT 5	BIT 4	BIT 3	BIT 2	BIT 1	BIT 0
--	--	--	-	Manual fan 1= toggle	(*) Reset CPU_Error	(*) Reset historical data	(*) Zero. BIT: RESET has taken place

CHn SETTING

BIT 7	BIT 6	BIT 5	BIT 4	BIT 3	BIT 2	BIT 1	BIT 0
--	--	--	--	FAN_INT	FAN2	FAN1	CAN_enabled

CHn STATUS

BIT 7	BIT 6	BIT 5	BIT 4	BIT 3	BIT 2	BIT 1	BIT 0
--	TRIP	ALARM	FAN_2	FAN_1	FCD	FOC	FCC

CHn STORY

BIT 7	BIT 6	BIT 5	BIT 4	BIT 3	BIT 2	BIT 1	BIT 0
--	TRIP	ALARM	--	--	--	FOC	FCC

RELAY STATUS (coil energizing status)

BIT 7	BIT 6	BIT 5	BIT 4	BIT 3	BIT 2	BIT 1	BIT 0
--	--	--	FAULT Relay 1=No Fault	TRIP Relay 1=ON	ALARM Relay 1=ON	FAN_2 Relay 1=ON	FAN_1 Relay 1=ON

CPU ERROR

BIT 7	BIT 6	BIT 5	BIT 4	BIT 3	BIT 2	BIT 1	BIT 0
--	--	--	--	PT ERROR	CAL	FCD Fault	ECH

CPU SETTING

0 BIT 7	BIT 6	BIT 5	BIT 4	BIT 3	BIT 2	BIT 1	BIT 0
--	--	--	Failsafe fault (always=1)	Failsafe trip	Failsafe alarm	HYSTERESIS TRIP	HYSTERESIS ALARM

ETHERNET MODULE PROGRAMMING PARAMETER

X Windows Vista, 7, 8.

ETH0 CONNECTIONS

Using an Ethernet cable, connect the ETH0 of the T1048 control unit to the ethernet card of a PC.

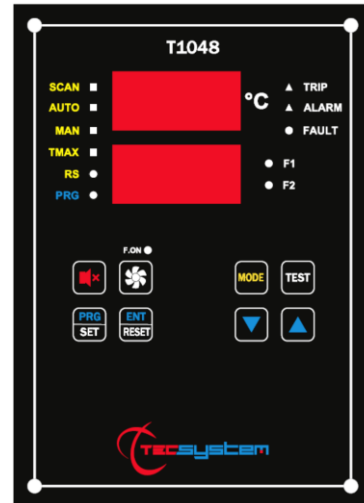

TELNET ENABLING

Use the Telnet program to set the Ethernet IP parameters.

1) START menu (Windows)



If already enabled, the program appears

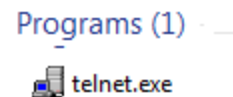

2) Start the search with the Telnet program
Entering telnet in SEARCH.

Press ENTER to launch the program.
(Go to step 12 on page 28)

If the Telnet program is not enabled:

3) START menu (Windows):

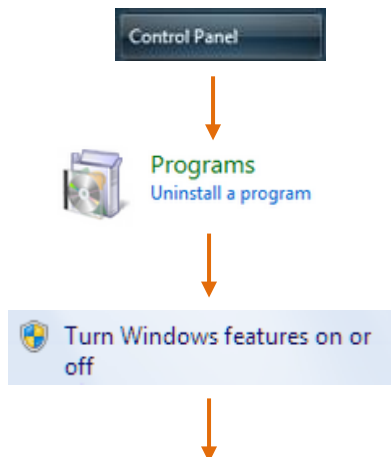

4) Select Control panel

5) Select Programs, followed by Features or Programs and Features

6) Select Turn Windows features on or off

7) Enable Telnet Client and click "OK"

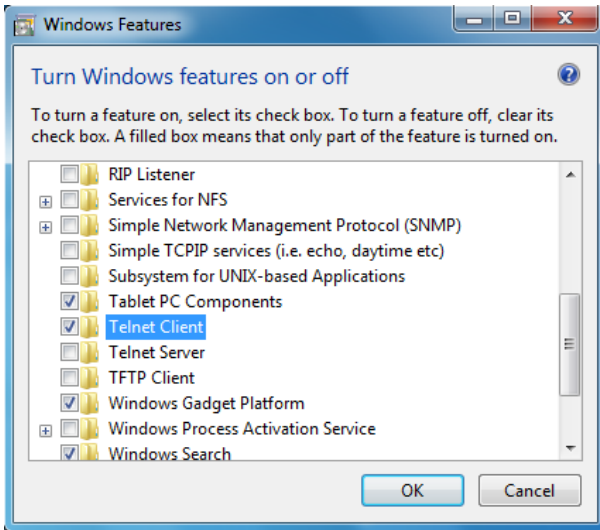

The screen below will open.
Wait for the Telnet function to activate.

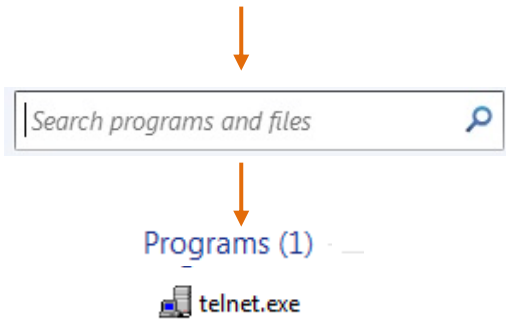
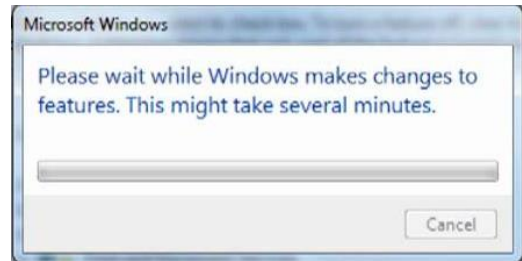

8) Close the open screens and restart the PC if required

9) START menu (Windows)

10) Search for the Telnet program

11) Press ENTER to launch the program

12) TELNET SCREEN

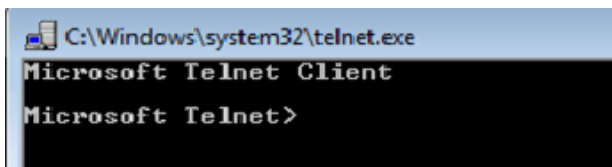

13) Enter: OPEN

14) Press ENTER

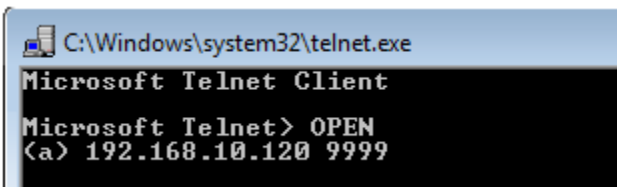

15) Enter: 192.168.10.120 9999

16) Press ENTER

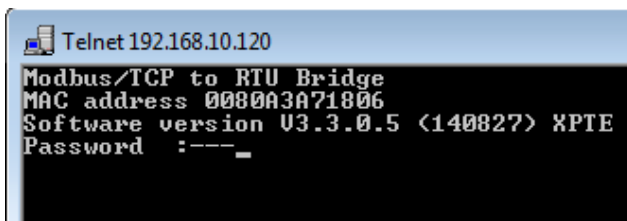

17) Enter the Password: TECS

18) Press ENTER

Note: In this screen we have the MAC address and the software version of the ETH port available.

19) IP PARAMETER PROGRAMMING MENU

```
Telnet 192.168.10.120
Modbus/TCP to RTU Bridge
MAC address 0080A3A71806
Software version U3.3.0.5 <140827> XPTC
Password :----
Press Enter for Setup Mode

Model: Device Server Plus+! <Firmware Code:YM>

Modbus/TCP to RTU Bridge Setup
1) Network/IP Settings:
  IP Address ..... 192.168.10.120
  Default Gateway ..... 192.168.10.1
  Netmask ..... 255.255.255.0
  Telnet config password set
2) Serial & Mode Settings:
  Protocol ..... Modbus/RTU,Slave(s) attached
  Serial Interface ..... 19200,8,E,1,RS485
3) Modem/Configurable Pin Settings:
  CP1 ..... RS485 Output Enable
  CP2 ..... Not Used
  CP3 ..... Not Used
4) Advanced Modbus Protocol settings:
  Slave Addr/Unit Id Source .. Modbus/TCP header
  Modbus Serial Broadcasts ... Disabled (Id=0 auto-mapped to 1)
  MB/TCP Exception Codes .... Yes (return 00AH and 00BH)
  Char, Message Timeout ..... 00050msec, 05000msec
7) Security Settings:
  SNMP ..... Enabled
  SNMP Community Name ..... public
  Telnet Setup ..... Enabled
  TFTP Download ..... Enabled
  Port 77FEh ..... Enabled
  Web Server ..... Enabled
  Enhanced Password ..... Disabled
  Port 77F0h ..... Enabled

D)default settings, S)ave, Q)uit without save
Select Command or parameter set <1..7> to change: _
```

IP PARAMETER PROGRAMMING MENU (TELNET)

The TELNET menu allows you to modify the configuration parameters of the Ethernet port.

The information available to you is:

Parameters that can be modified by the operator

- 1) Parameter modification (IP Address - Gateway- Netmask -Telnet password).

Parameters that cannot be modified by the operator

- 2) Communication parameters between the ETH0 port and the control unit.
- 3) Communication configuration between the ETH0 port and the control unit.
- 4) Communication advanced settings between the ETH0 port and the control unit.
- 7) Security settings between the ETH0 port and the control unit.



IMPORTANT WARNING

For the device to work correctly, we advise you not to access or modify menus 2-3-4-7. The modification of the values in the stated menus might cause communication anomalies with the loss of the Ethernet IP communication.

MENU MODIFICATION PROCEDURE 1) IP parameters:

enter the command: 1

```
IP Address: IP Address <192> 192.<168> 168.<010> .<120> 120_
```

1) Enter the desired new IP address, if you wish to keep the set address press ENTER 4 times.

- At the end of the operation, the system will ask if you wish to modify the Gateway IP:

```
IP Address <192> 192.<168> 168.<010> .<120> 120  
Set Gateway IP Address <N> ?
```

Enter: **Y** to modify the Gateway IP.

N not to modify the Gateway IP and go to the following step.

2) Enter the desired new Gateway IP address, press ENTER; if you wish to keep the set address press ENTER 4 times.

```
IP Address <192> 192.<168> 168.<010> .<120> 120  
Set Gateway IP Address <N> ? Y  
Gateway IP Address : <192> 192.<168> 168.<010> 10.<001> 001_
```

- At the end of the operation, the system will ask if you wish to modify Netmask:

```
IP Address <192> 192.<168> 168.<010> .<120> 120  
Set Gateway IP Address <N> ? Y  
Gateway IP Address : <192> 192.<168> 168.<010> 10.<001> 001  
Set Netmask <N for default> <N> ?
```

Enter: **Y** to modify Netmask.

N not to modify Netmask and go to the following step.

3) Enter the new Netmask, press ENTER; if you wish to keep the set address press ENTER 4 times.

```
IP Address <192> 192.<168> 168.<010> .<120> 120  
Set Gateway IP Address <N> ? Y  
Gateway IP Address : <192> 192.<168> 168.<010> 10.<001> 001  
Set Netmask <N for default> <N> ? Y  
<255> .<255> .<255> .<000> _
```

- At the end of the operation, the system will ask if you wish to modify the Telnet Password:

```
IP Address <192> 192.<168> 168.<010> .<120> 120  
Set Gateway IP Address <N> ? Y  
Gateway IP Address : <192> 192.<168> 168.<010> 10.<001> 001  
Set Netmask <N for default> <N> ? Y  
<255> .<255> .<255> .<000>  
Change telnet config password <N> ? _
```

Enter: **Y** to modify the Telnet Password.

N not to modify the Telnet Password and go to the following step.

```

IP Address <192> 192.<168> 168.<010> .<120> 120
Set Gateway IP Address <N> ? Y
Gateway IP Address : <192> 192.<168> 168.<010> 10.<001> 001
Set Netmask <N for default> <N> ? Y
<255> .<255> .<255> .<000>
Change telnet config password <N> ? Y
Enter new Password:

```

4) Enter the new Telnet Password (4 digits max), press ENTER; if you wish to keep the set Password, press ENTER.

```

D>default settings, S>ave, Q>uit without save
Select Command or parameter set <1..7> to change: _

```

Enter: S to save the modified data.
Q to exit Telnet without saving the data.

The following screen will be displayed:

```

→ D>default settings, S>ave, Q>uit without save
Select Command or parameter set <1..7> to change:
Parameters saved, Restarting ...

```

To check the programmed parameters or repeat programming, follow the TELNET SCREEN from step 12 to step 19, page 28.

Indications of LEDs 1-2 of the Ethernet port:

LED 1: Link

- > Off = No link
- > Amber = 10 Mbps
- > Green = 100 Mbps

LED 2: Activity

- > Off = No Activity
- > Amber = Half Duplex
- > Green = Full Duplex



FAIL SAFE FUNCTION

The T1048 has n.o selection (contact) / n.c (normally closed contact) for alarm and trip relays, programming steps 32 to 35 page 14. The selection of the setting no / nc introduces functions Fail Safe and No Fail Safe.

Setting n.o (No Fail safe) normally open contacts are in positions 5-7 and 8-10 Alarm Trip, they switch only when limits are reached preset temperature.

By setting n.c (Fail Safe) normally closed contacts are in positions 5-7 and 8-10 Alarm Trip, they switch only when limits are reached preset temperature.

NOTE: When the unit is located in one of the methods described below does not monitor heat, also the relay will all be banned:

- Vis. display programming.
- PRG programming.
- Test of the relays.

Pt100 EXTENSION CABLE TECHNICAL SPECIFICATIONS

1. Cable 20 x AWG 20/19 Cu/Sn
2. Section 0.55 mm²
3. Flame retardant insulation PVC105
4. CEI 20.35 IEC 332.1 regulations
5. Maximum operating temperature: 90°C
6. Conformation: 4 sets of three twisted and coloured conductors
7. Shield in Cu/Sn
8. Flame retardant PVC sheath
9. External diameter 12mm
10. Standard conformation in 100m coils

FCD FUNCTION

The T series equipment boasts an innovative control function combined with the dynamic status of the sensor.

Activating FCD, the control unit analyses the increase in temperature ΔT (*) recorded in a second (°C/sec).

Enabling the function, the user can select the value (ΔT) from a minimum of 1°C/sec to a maximum of 30°C/ sec. If the value sensed is higher than the value set by the user, the control unit inhibits the possible activation of the ALARM and TRIP alarms and switches the FAULT relay (11-12), displaying the message "**Fcd fault**".

Example: if we set the function to 5°C, FAULT will switch for FCD only if the control unit senses an increase in ΔT of over 5°C in a second on the monitored system.

Setting "no" disables the FCD function.

When a channel is in FAULT for FCD, the relative Alarm and Trip warnings are inhibited on the single channel; therefore only the over-quick temperature increase is highlighted.

Press Reset to delete the FCD warnings on all channels and reset the FAULT relay.

Possible FCD applications

Identification of a possible induced interference on the sensor line

If the installation instructions are not complied with (see page 16), any interference on the sensor line can cause false readings or anomalous alarms.

Setting the FCD function in a temperature range of between 1°C and 10°C (5°C recommended), the effects caused by false readings can be suppressed and the alarm relay activation can be prevented, as shown above.

Corrective actions: check the installation of the sensor extension cable is in line with the instructions given in the paragraph on the measurement signal transfer on page 16.

Identification of a sensor fault or faulty connection

In case of a faulty connection or sensor fault, a quick positive or negative variation in temperature might occur, leading to the system tripping or the alarms of the monitored system to be triggered.

In this specific case we recommend the FCD function to be set in a temperature range of between 10°C and 20°C.

Corrective actions: check the terminals the sensor is connected to are tightened and replace the faulty sensor, if required.

Identification of the electrical motor rotor block

In case of temperature control of the electrical motors, the quick temperature increase might be due to a blocked rotor.

In this specific case we recommend the FCD function to be set in a temperature range of between 20°C and 30°C. This setting is recommended in order to prevent the FCD function from activating during motor start-up, or where the ΔT /sec. increase varies quickly.

(*) The ΔT value shows the temperature range for each second.

NOTE: you should not enable the FCD function with active VOTING.

WARRANTY CONDITIONS

The Product purchased is covered by the manufacturer's or seller's warranty at the terms and conditions set forth in the "Tecsystem s.r.l.'s General Conditions of Sale", available at www.tecsystem.it and / or purchase agreement.

The warranty is considered valid only when the product is damaged by causes attributable to TECSYSTEM srl, such as manufacturing or components defects.

The warranty is invalid if the Product proves to have been tampered with / modified or incorrectly connected and causing voltages outside the set limits and does not comply with the technical data for use and assembly, as described in this instruction manual.

The warranty is always ex Corsico as stated in the "General Conditions of Sale".

TROUBLESHOOTING	CAUSES AND SOLUTIONS
The control unit does not switch on and the supply to terminals 40-42 is correct.	Check that: the plug is firmly secured in place, the connection wires are tight, the fuse is not blown. there are no obvious signs of burn marks on the connectors. Remove power and run as previously indicated, turn it ON (replace the fuse).
FOC FAULT on CHn	Programming error of the CHn / YES control unit. <i>Check and repeat programming as per page 13-14, select CHn / NO.</i>
One of the three / four channels is in FAULT to FCC or shows a negative temperature (TCK)	Check connections + yellow and - red, restore the correct connection.
One of the three/four channels is in FAULT due to FOC/FCC (PT100)	Check the connections of the Pt100 sensors, check the instructions given in the paragraphs: <i>measurement signal transfer and temperature sensor diagnostics on page 16-17.</i>
When turning on, the display shows "ECH"	Strong interference damaged the stored data. See the paragraph Programmed data diagnostics on page 18.
One of the three / four channels is in FAULT for FOC / FCC	Check if the temperature reached minimum/maximum values full scale of the sensors -23 ° C and + 228 ° C, check the correct connection of the probes.
All the PT100 sensors are in FCC.	Incorrect sensor connection, the terminal block has been inserted upside down. <i>Check the connections and the terminal board.</i>
The temperature shown by one or more channels is wrong.	Contact the <i>TECSYSTEM Technical Department.</i>
Sudden trip of the main switch. The temperature is on standard levels. Just one channel has caused the trip.	Check the temperatures recorded in T-MAX, check the instructions given in the paragraphs: <i>measurement signal transfer and temperature sensor diagnostics on page 16-17. Activate the FCD function.</i>
FCD warning	See the FCD function on page 32.
One or both of ventilation lines do not function.	Check the fuses FAN 1 and FAN2, replace the defective fuses.
Contact <i>TECSYSTEM Technical Department</i> if the problem persists.	

EQUIPMENT DISPOSAL

European directive 2012/19/EU (WEEE) has been approved to reduce electrical and electronic waste and promote the recycling and reuse of the materials and components of said equipment, cutting down on the disposal of the residues and harmful components of electrical and electronic materials.



All the electrical and electronic equipment supplied after 13 August 2005 is marked with this symbol, pursuant to European directive 2012/19/EU on electrical and electronic waste (WEEE). Any electrical or electronic equipment marked with this symbol must be disposed of separately from normal domestic waste.

Returning used electrical devices: contact TECSYSTEM or your TECSYSTEM agent for information on the correct disposal of the devices.

TECSYSTEM is aware of the impact its products have on the environment and asks its customers active support in the correct and environmentally-friendly disposal of its devices.

USEFUL CONTACTS

TECHNICAL INFORMATION : ufficiotecnico@tecsystem.it

SALES INFORMATION : info@tecsystem.it



UL SPECIFICATION AND RATINGS

CABLE SPECIFICATION	Dimension for main circuit 18AWG, working temperature over 90°C
MASS OF THE EQUIPMENT	0,62 Kg
INPUT SUPPLY	100 – 240 Vac / Vdc \pm 10%, 50/60 Hz 8VA max
PROTECTION	External switch or circuit breaker
OUTPUTS RELAYS	5 Outputs relays: 10A – 250Vca-res COS=1
OPTIONAL PORTS	RS485 or Ethernet