

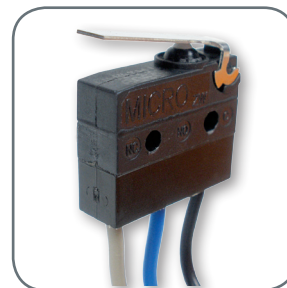

MICRO SWITCH™ Sealed
Subminiature Basic Switches
ZW Series



MICRO SWITCH™ ZW Series

Sealed Subminiature Basic Switches

Honeywell's MICRO SWITCH™ ZW Series is a sealed subminiature snap action switch from the Honeywell family of Z Series subminiature basic switches. Although small in size, the ZW Series is rated for controlling electrical loads ranging from logic level/computer-based circuits to power-duty switching (up to 6 amps and up to 250 Vac).

Switches supplied with integral wire leads are sealed to IP67 and are suitable for applications where a switch assembly would be exposed to liquids or particulate contaminants in the environment from indoor or outdoor use.

A wide variety of stainless steel levers are available and when combined with the subminiature package size, can adapt the switch for many different applications. The ZW Series is certified to UL, cUL, ENEC, and CQC for worldwide use.

What makes our switches better?

- The IP67-rated sealed switch is designed to operate in a variety of demanding applications, reducing the challenge of harsh environments
- Wide variety of electrical current carrying capacity allows for a solution in many systems
- Switch package designed to accommodate a wide range of temperature requirements



For worldwide use...

RIGHT SWITCH FOR THE RIGHT APPLICATION
HARSH ENVIRONMENTS • RELIABILITY • ELECTRICAL RATING

Features and Benefits

SMALL PACKAGE SIZE

Subminiature package size allows the MICRO SWITCH™ ZW Series switch to fit in many applications where other sensors or switches are too large.

IP67 sealing: pre-wired switches

WELL SUITED FOR POWER-DUTY AND LOGIC-LEVEL LOADS

SPDT, SPNC, or SPNO switch options are available and designed to meet various circuit requirements. ZW Series can control **power-duty switching** with silver contacts or **logic-level** computer-based circuits with gold-plated contacts.

PERFORMS IN WET, DIRTY, AND DUSTY ENVIRONMENTS

Catalog listings with integral lead wires are sealed to IP67 **for use in environments where exposure to liquid ingress or particulate contaminant could occur.**

DESIGN FLEXIBILITY

Switches are built with **an integral sealed pin plunger.** Various styles of levers expand the versatility of the ZW Series switch in the application. In addition, the ZW Series features a **variety of terminations** to promote flexibility for the electrical connectivity.

Potential Applications



LAWN TRACTORS

Reverse alarm for lawn tractors
Indicates seat use on lawn tractors

WATERCRAFT

Found on handle-bar controls for personal watercraft (wave runners)

SECURITY SYSTEMS

Acts as an interlock for security system panel



SNOWMOBILES

Found on handle-bar controls for snowmobiles

ZW Series

PRODUCT NOMENCLATURE

ZW	50	F	15	A	D	1	—
Switch Type	Current Rating	Operating Force ⁴ (at pin plunger)	Terminal Type	Actuator Type ³ (Levers Mounted Internally)	Construction	Circuitry	Special Designator ³
ZW Series Sealed Subminiature Basic Switch	10 0,1A 125/250 Vac (Gold-plated contacts)	E 150 g max.	15 Solder	A Pin plunger	D IP00 Dust tight	1 SPDT	A special designator is used to indicate a non-standard feature, such as a special actuator, wire color, wire length, connector, etc. This code consists of up to three alphanumeric characters.
	50 6A: 125/250 Vac (Silver contacts) ONLY	F 203 g max.	20 PCB, straight	B Short straight lever (17,4 mm)	W IP67 Water tight	3 SPNO ²	
			70 Long solder 2,8 mm x 0,5 mm [0.11 in x 0.02 in]	C Standard straight lever (19,4 mm)		4 SPNC ²	
			90 Cable, bottom exit (500 mm) (UL10007 Dia 1.0) ^{5,6}	D Long straight lever (25,5 mm)			
			91 Cable, side exit (Opposite plunger) (500 mm) (UL1007 Dia) ^{5,6}	E Simulated roller lever (18,7 mm; R 3,4 mm)			
			92 Cable, side exit (Plunger end) (500 mm) (UL1007 Dia) ^{5,6}	F Roller lever (17,2 mm; Ø 4,8 mm)			
			99 SPECIAL ³	H Small simulated roller lever (18,6 mm; R1,3 mm)			
				J Long straight lever (55,9 mm)			
				S SPECIAL Lever ²			

NOTES:

¹ Not all combinations of model code are available. Please contact your Honeywell provider/representative for assistance.

² Termination style "99" and/or Actuator Type "S" designates a special and therefore requires a special designator letter at the end of the listing

³ Lever length is measured as follows: Straight lever - from center line of the pivot to the end of the lever; Roller and simulated roller lever - from the center line of the pivot to the center of the roller diameter. See page 8 for more details.

⁴ Standard wire length is 500 mm [19.68 in] long. Other lengths are available upon request. Lead wire with end stripped 3,0 mm [0.118 in] and pre-tinned.

COM: black; NC: gray; NO: blue

⁵ Standard lead wire is UL1007 20 AWG cable. Other lead wire types, such as UL1015, UL1430, UL1061, and AVSS are available upon request.

MICRO SWITCH™ Sealed Subminiature Basic Switches

Table 1. Specifications

Characteristic	ZW10 Series (Logic Level)	ZW50 Series (Power Duty)
Circuitry	SPDT, SPNC, SPNO	SPDT, SPNC, SPNO
Operating force	150 g or 203 g @ plunger	150 g or 203 g @ plunger
Termination	PCB, solder, prewired	PCB, solder, prewired
Sealing	IP67 (prewired), IP00 for exposed terminals	IP67 (prewired), IP00 for exposed terminals
Actuators (levers 300 series stainless steel)	pin plunger, flat lever, roller lever, sim. roller lever, special levers	pin plunger, flat lever, roller lever, sim. roller lever, special levers
Agency certification	UL, cUL, ENEC, CQC, RoHS compliant	UL, cUL, ENEC, CQC, RoHS compliant
Operating temperature (Manufacturer rated)	-40 °C to 120 °C [-40 °F to 248 °F] (terminal) -20 °C to 70 °C [-4 °F to 158 °F] (pre-wired)	-40 °C to 120 °C [-40 °F to 248 °F] (terminal) -20 °C to 70 °C [-4 °F to 158 °F] (pre-wired)
Mechanical endurance (cycles)	1,000,000 min. @ 120 cycles/minute max.	1,000,000 min. @ 120 cycles/minute max.
Switch resistance (initial)	50 mΩ max. (terminals); 100 mΩ max (pre-wired)	50 mΩ max. (terminals); 100 mΩ max (pre-wired)
Insulation resistance (initial)	100 MΩ min. (500 Vdc for one minute)	100 MΩ min. (500 Vdc for one minute)
Dielectric strength (initial) (between live parts and ground)	1500 VRMS for one minute ≤0.5 mA leakage current	1500 VRMS for one minute ≤0.5 mA leakage current
Plunger seal	silicone	silicone
Contact material	gold-plated silver	silver
Housing material	case, PBT (polyester); cover, PBT (polyester)	case, PBT (polyester); cover, PBT (polyester)

Note: Refer to engineering drawing for additional information.

Table 2. Electrical Ratings

Switch option	CQC (Asia-Pacific) Per GB 15092-1	ENEC (Europe) Per IEC 61058-1	UL, cUL (Americas) UL 61058-1, File 12252
ZW10 Series (Gold-plated contacts)	0.1 A, 125/250 Vac 10,000 cycles	0.1 A, 250 Vac 10,000 cycles	0.1 RA, 125/250 Vac 10,000 cycles
ZW50 Series (Silver contacts)	6 A, 125/250 Vac 10,000 cycles	6 A, 250 Vac 10,000 cycles	5 RA, 125/250 Vac 10,000 cycles

Note: The agency “use temperature” for solder or PCB terminals: 0 °C to 120 °C [32 °F to 248 °F];

CQC/ENEC “use temperature” for wire leads: 0 °C to 70 °C [32 °F to 158 °F].

UL/cUL “use temperature” for wire leads: 0 °C to 55 °C [32 °F to 131 °F].

ZW Series

- O.F. • Operating force
- R.F. • Release force
- P.T. • Pretravel
- O.T. • Overtravel
- D.T. • Differential travel
- O.P. • Operating position

PRODUCT SPECIFICATIONS AND LISTINGS

Contact your Honeywell rep or distributor for additional listings

	Catalog Listing	Actuator	Circuitry/ Contact Material	Elect. Rating Spec. (page 5)	Termination	O.F. max. N [g]
 <p>Pin plunger</p>	ZW10F20AD1	Pin plunger	SPDT/ Gold plate	0.1 A	PCB	2,00 N [203 g]
	ZW10F90AW1	Pin plunger	SPDT/ Gold plate	0.1 A	Wire leads, bottom exit (500 mm)	2,00 N [203 g]
	ZW50F15AD1	Pin plunger	SPDT/ Silver	6 A	Solder	2,00 N [203 g]
	ZW50F90AW1	Pin plunger	SPDT/ Silver	6 A	Wire leads, bottom exit (500 mm)	2,00 N [203 g]
	ZW50F92AW3	Pin plunger	SPNO/ Silver	6 A	Wire leads, side exit, plunger side (500 mm)	2,00 N [203 g]
 <p>Std. straight lever</p>	ZW10E15CD1	Standard straight lever, 19,4 mm [0.76 in]	SPDT/ Gold plate	0.1 A	Solder	0,54 N [55 g]
	ZW50F90CW3	Standard straight lever, 19,4 mm [0.76 in]	SPNO/ Silver	6 A	Wire leads, bottom exit (500 mm)	0,65 N [66 g]
	ZW50F92CW3	Standard straight lever, 19,4 mm [0.76 in]	SPNO/ Silver	6 A	Wire leads, side exit, plunger side (500 mm)	0,65 N [66] g
 <p>Long straight lever</p>	ZW50F90DW1	Long straight lever, 25,5 mm [1.0 in]	SPDT/ Silver	6 A	Wire leads, bottom exit (500 mm)	0,53 N [54 g]
	ZW50F90JW1	Longer straight lever, 52,9 mm [2.20 in]	SPDT/ Silver	6 A	Wire leads, bottom exit (500 mm)	0,32 N [33 g]
 <p>Sim. roller lever</p>	ZW50F90EW3	Sim. roller lever, 18,65 mm [0.73 in] radius: 3,4 mm [0.13 in]	SPNO/ Silver	6 A	Wire leads, bottom exit (500 mm)	0,68 N [69 g]
 <p>Sim. roller lever</p>	ZW50F90HW1	Small radius, sim. roller lever, 18,6 mm [0.73 in] radius: 1,3 mm [0.05 in]	SPDT/ Silver	6 A	Wire leads, bottom exit (500 mm)	0,67 N [68 g]
	ZW50F91HW1	Small radius, sim. roller lever, 18,6 mm [0.73 in] radius: 1,3 mm [0.05 in]	SPDT/ Silver	6 A	Wire leads, side exit, opposite plunger (500 mm)	0,67 N [68 g]
 <p>Roller lever</p>	ZW10E70FD1	Roller lever, 17,2 mm [0.68 in]	SPDT/ Gold plate	0.1 A	Solder (long terminal)	0,59 N [60 g]
	ZW10E90FW1	Roller lever 17,2 mm [0.68 in]	SPDT/ Gold plate	0.1 A	Wire leads, bottom exit (500 mm)	0,59 N [60 g]
	ZW50F90FW1	Roller lever 17,2 mm [0.68 in]	SPDT/ Silver	6 A	Wire leads, bottom exit (500 mm)	0,71 N [72 g]

MICRO SWITCH™ Sealed Subminiature Basic Switches

O.F. • Operating force
 R.F. • Release force
 P.T. • Pretravel
 O.T. • Overtravel
 D.T. • Differential travel
 O.P. • Operating position

R.F. max. N [g]	O.P. from mounting hole mm [in] (see page 8)	O.P. from base of terminal mm [in] (see page 8)	P.T. max.	O.T. min.	D.T. max.
0,49 N [50 g]	–	11,5 ±0,3 [0.45 ±0.012]	1,2 mm [0.05 in]	0,6 mm [0.02 in]	0,2 mm [0.01 in]
0,49 N [50 g]	8,4 ±0,3 [0.33 ±0.012]	–	1,2 mm [0.05 in]	0,6 mm [0.02 in]	0,2 mm [0.01 in]
0,49 N [50 g]	8,4 ±0,3 [0.33 ±0.012]	–	1,2 mm [0.05 in]	0,6 mm [0.02 in]	0,2 mm [0.01 in]
0,49 N [50 g]	8,4 ±0,3 [0.33 ±0.012]	–	1,2 mm [0.05 in]	0,6 mm [0.02 in]	0,2 mm [0.01 in]
0,49 N [50 g]	8,4 ±0,3 [0.33 ±0.012]	–	1,2 mm [0.05 in]	0,6 mm [0.02 in]	0,2 mm [0.01 in]
0,11 N [11 g]	8,8 ±1,2 [0.35 ±0.047]	–	4,8 mm [0.19 in]	1,0 mm [0.04 in]	0,7 mm [0.03 in]
0,13 N [13 g]	8,8 ±1,2 [0.35 ±0.047]	–	4,8 mm [0.19 in]	1,0 mm [0.04 in]	0,7 mm [0.03 in]
0,13 N [13 g]	8,8 ±1,2 [0.35 ±0.047]	–	4,8 mm [0.19 in]	1,0 mm [0.04 in]	0,7 mm [0.03 in]
0,11 N [11 g]	8,8 ±1,6 [0.35 ±0.063]	–	6,3 mm [0.25 in]	1,6 mm [0.06 in]	0,9 mm [0.04 in]
0,07 N [7 g]	8,8 ±3,5 [0.34 ±0.138]	–	13,8 mm [0.54 in]	2,9 mm [0.11 in]	3,60 mm [0.14 in]
0,13 N [13 g]	11,7 ±1,15 [0.46 ±0.045]	–	4,7 mm [0.18 in]	0,9 mm [0.04 in]	0,75 mm [0.03 in]
0,14 N [14 g]	10,7 ±1,2 [0.42 ±0.047]	–	4,6 mm [0.18 in]	1,0 mm [0.04 in]	0,75 mm [0.03 in]
0,14 N [14 g]	10,7 ±1,2 [0.42 ±0.047]	–	4,6 mm [0.18 in]	1,0 mm [0.04 in]	0,75 mm [0.03 in]
0,12 N [12 g]	14,5 ±1,1 [0.57 ±0.043]	–	4,3 mm [0.17 in]	0,9 mm [0.04 in]	0,6 mm [0.02 in]
0,12 N [12 g]	14,5 ±1,1 [0.57 ±0.043]	–	4,3 mm [0.17 in]	0,9 mm [0.04 in]	0,6 mm [0.02 in]
0,15 N [15 g]	14,5 ±1,1 [0.57 ±0.043]	–	4,3 mm [0.17 in]	0,9 mm [0.04 in]	0,6 mm [0.02 in]

MOUNTING DIMENSIONS

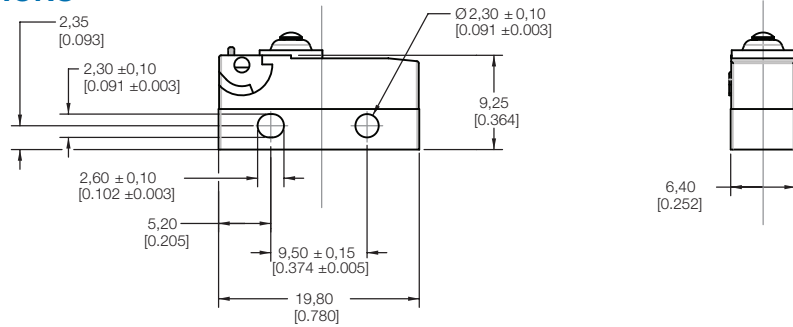

Note: unless otherwise noted, a tolerance of $\pm 0,4$ mm applies to all dimensions.

TERMINAL TYPES

TYPE 15 - SOLDER (STRAIGHT)

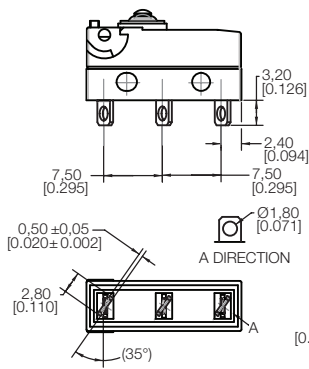

TYPE 20 - PCB (STRAIGHT)

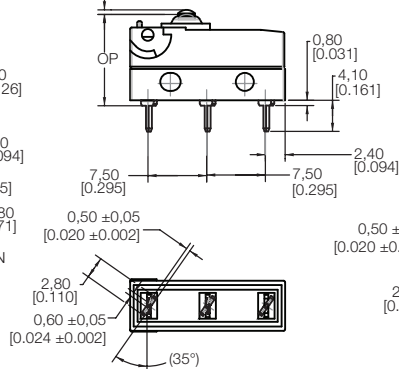

TYPE 70 - LONG SOLDER TERMINALS

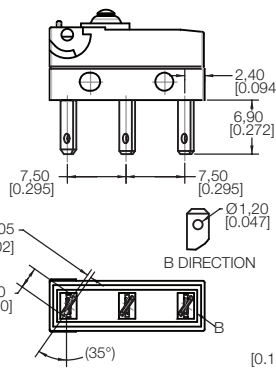

TYPE 90 - CABLE-BOTTOM EXIT

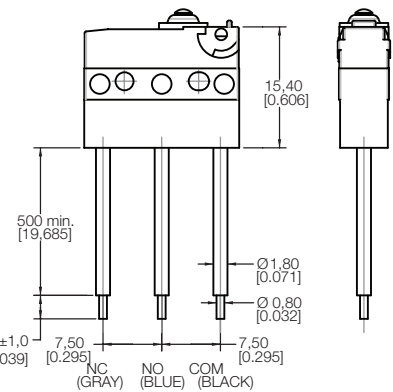

TYPE 91 - CABLE-SIDE EXIT [OPPOSITE PLUNGER END]

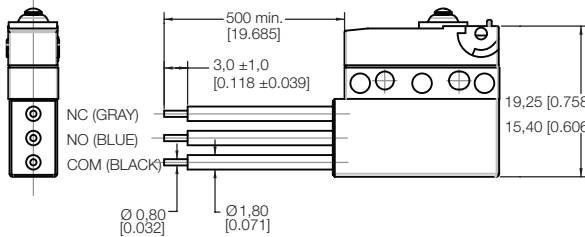

TYPE 92 - CABLE-SIDE EXIT [PLUNGER END]

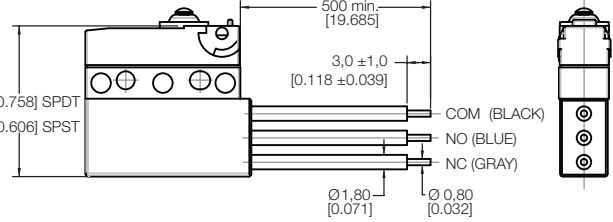

ACTUATOR TYPES (ALL ACTUATORS EXCEPT TYPE A AND F ARE 4.0 WIDE)

TYPE A PIN PLUNGER

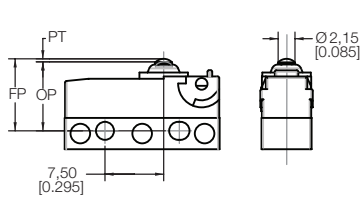

TYPE B SHORT STRAIGHT LEVER (17.4MM)

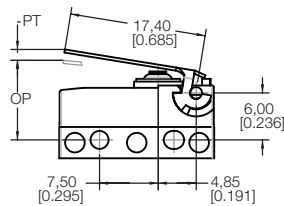

TYPE C STANDARD STRAIGHT LEVER (19.4mm)

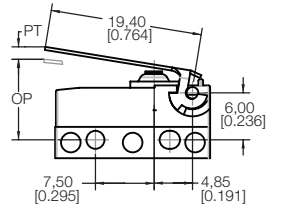

TYPE D LONG STRAIGHT LEVER (25.5MM)

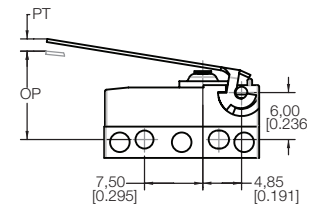

TYPE E SIMULATED ROLLER LEVER (18.7MM,R3.4)

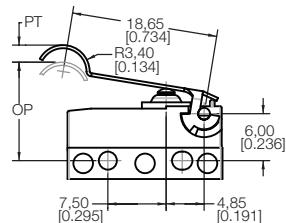

TYPE F ROLLER LEVER (17.2MM, ROLL Ø4.8)

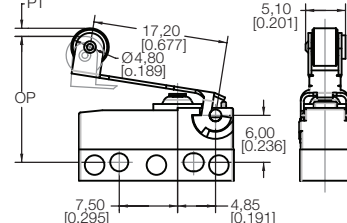

TYPE H SMALL SIMULATED ROLLER LEVER (18.6MM,R1.3)

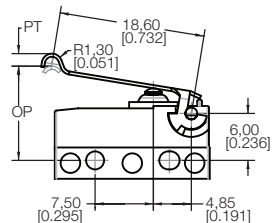

TYPE J LONGEST STRAIGHT LEVER (55.9MM)

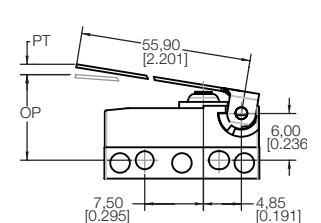

ADDITIONAL INFORMATION

The following associated literature is available on the Honeywell web site at sensing.honeywell.com:

- Product installation instructions
- Product range guide
- Product nomenclature tree
- Product application-specific information
 - Case study: Stamp of approval, ZW Series
 - Application note: Sensors and switches for potential HVAC/R applications
 - Application note: Sensors and switches in industrial air compressors
 - Application note: Sensors and switches in sanitary valves
 - Application note: Sensors and switches in valves and flow meters
 - Application note: Sensors and switches for potential medical applications
 - Application note: Sensors and switches for valve monitors and valve indicators
 - Application note: Watertight switches in transportation applications
 - Technical bulletin: Applying precision switches
 - Technical bulletin: Low energy switch guide

Find out more

Honeywell serves its customers through a worldwide network of sales offices, representatives and distributors. For application assistance, current specifications, pricing or name of the nearest Authorized Distributor, contact your local sales office.

To learn more about Honeywell's sensing and switching products, call **+1-815-235-6847** or **1-800-537-6945**, visit **sensing.honeywell.com**, or e-mail inquiries to **info.sc@honeywell.com**

Sensing and Productivity Solutions
Honeywell
1985 Douglas Drive North
Golden Valley, MN 55422
honeywell.com

WARNING **PERSONAL INJURY**

DO NOT USE these products as safety or emergency stop devices or in any other application where failure of the product could result in personal injury.

Failure to comply with these instructions could result in death or serious injury.

WARNING **MISUSE OF DOCUMENTATION**

- The information presented in this product sheet is for reference only. Do not use this document as a product installation guide.
- Complete installation, operation, and maintenance information is provided in the instructions supplied with each product.

Failure to comply with these instructions could result in death or serious injury.

WARRANTY/REMEDY

Honeywell warrants goods of its manufacture as being free of defective materials and faulty workmanship. Honeywell's standard product warranty applies unless agreed to otherwise by Honeywell in writing; please refer to your order acknowledgement or consult your local sales office for specific warranty details. If warranted goods are returned to Honeywell during the period of coverage, Honeywell will repair or replace, at its option, without charge those items it finds defective. **The foregoing is buyer's sole remedy and is in lieu of all other warranties, expressed or implied, including those of merchantability and fitness for a particular purpose. In no event shall Honeywell be liable for consequential, special, or indirect damages.**

While we provide application assistance personally, through our literature and the Honeywell website, it is up to the customer to determine the suitability of the product in the application.

Specifications may change without notice. The information we supply is believed to be accurate and reliable as of this printing. However, we assume no responsibility for its use.

Honeywell